



## PROCUREMENT SERVICES

Request for Proposal

RP-020-25

Lynn Soccer Stadium

Graphic Updates

Proposal Due Date

03/20/2025 at 2:00 PM, EST

# UNIVERSITY OF LOUISVILLE

## PROCUREMENT SERVICES

### Request for Proposal (RFP)

|  |   |
|--|---|
| <b>Proposal Number:</b> RP-020-25  | <b>DELIVER ORIGINAL COPY OF PROPOSAL TO:</b>                                    |
| <b>Speed type:</b> A0234   | University of Louisville  |
| <b>Issue Date:</b> 2/27/2025   | Procurement Services  |
| <b>RFP Title:</b> Lynn Soccer Stadium Graphic Updates  | 2215 S Brook St., Room 107  |
| <b>Contract Administrator:</b> Jamie Peck  | Louisville, KY 40208  |
| <b>Contact Email:</b> <a href="mailto:Jamie.peck@louisville.edu">Jamie.peck@louisville.edu</a> | <b>Method of Award:</b> Competitive Negotiation per KRS <a href="#">45A.085</a> |

**IMPORTANT: PROPOSALS MUST BE RECEIVED BY 03/20/2025 at 2:00 PM, EST**

#### NOTICE OF REQUIREMENT

1. The University's General Terms and Conditions, viewable at [Procurement Terms and Conditions](#) apply to this RFP, as do the terms and conditions set forth in Section 5 of this RFP. **No other terms should be included.**
2. Contracts resulting from this RFP must be governed by and in accordance with the laws of the Commonwealth of Kentucky.
3. Any agreement or collusion among offerors or prospective offerors, which restrains, tends to restrain, or is reasonably calculated to restrain competition by agreement to bid at a fixed price or to refrain from offering, otherwise, is prohibited.
4. Any person who violates any provision of [KRS 45A.325](#) shall be guilty of a felony and shall be punished by a fine of not less than five thousand dollars, nor more than ten thousand dollars or be imprisoned not less than one year nor more than five years, or both such fine and imprisonment. Any firm, corporation, or association who violates any of the provisions of KRS 45A.325 shall, upon conviction, be fined not less than ten thousand dollars or more than twenty thousand dollars.

#### AUTHENTICATION OF BID AND STATEMENT OF NON-COLLUSION AND NON-CONFLICT OF INTEREST

I hereby swear (or affirm) under the penalty for false swearing as provided by [KRS 523.040](#):

1. That I am the offeror (if the offeror is an individual), a partner, (if the offeror is a partnership), or an officer or employee of the bidding corporation having authority to sign on its behalf (if the offeror is a corporation).
2. That the attached proposal has been arrived at by the offeror independently and has been submitted without collusion with, and without any agreement, understanding or planned common course of action with, any other contractor of materials, supplies, equipment, or services described in the RFP, designed to limit independent bidding or competition.
3. That the contents of the proposal have not been communicated by the offeror or its employees or agents to any person not an employee or agent of the offeror or its surety on any bond furnished with the proposal and will not be communicated to any such person prior to the official closing of the RFP.
4. That the offeror is legally entitled to enter into contracts with the University of Louisville and is not in violation of any prohibited conflict of interest, including, but not limited to, those prohibited by the provisions of [KRS 45A.330](#), [KRS 45A.335](#), [KRS 45A.340](#), and [KRS 164.390](#);
5. That the offeror, and its affiliates, are duly registered with the Kentucky Department of Revenue to collect and remit the sales and use tax imposed by [KRS Chapter 139](#) to the extent required by Kentucky law and will remain registered for the duration of any contract award;
6. That I have fully informed myself regarding the subject of the statements made above and all such statements are true and accurate.

#### SWORN STATEMENT OF COMPLIANCE WITH CAMPAIGN FINANCE LAWS

In accordance with [KRS 45A.110 \(2\)](#), the undersigned hereby swears under penalty of perjury that he/she has not knowingly violated any provision of the campaign finance laws of the Commonwealth of Kentucky and that the award of a contract to an offeror will not violate any provision of the campaign finance laws of the Commonwealth of Kentucky.

#### CONTRACTOR REPORT OF PRIOR VIOLATIONS OF KRS CHAPTERS 136, 139, 141, 337, 338, 341 & 342

The Contractor, by signing and submitting a proposal, agrees as required by [KRS 45A.485](#) to submit final determination of any violations of the provisions of KRS Chapters 139, 139, 141, 337, 338, 341 and 342 that have occurred in the previous five (5) years prior to the award of a contract and agrees to remain in continuous compliance with the provisions of the statutes during the duration of any contract that may be established. Final determinations of violations of these statutes must be provided to the University by the successful Contractor prior to the award of a contract.

#### CERTIFICATION OF NON-SEGREGATED FACILITIES

The Contractor, by submitting a proposal, certifies that he/she is in compliance with the Code of Federal Regulations [Title 41 CFR 60-1.8\(b\)](#) that prohibits the maintaining of segregated facilities.

**SIGNATURE REQUIRED:** This proposal may not be considered valid unless signed and dated below by an authorized agent of the offeror. Offers signed by an agent are to be accompanied by evidence of his/her authority unless such evidence has previously been furnished to the issuing office.

|                       |                                 |         |
|-----------------------|---------------------------------|---------|
| NAME OF COMPANY:      | FEDERAL EMPLOYER ID NO:         | DUNS#:  |
| ADDRESS:              | CITY, STATE & ZIP CODE:         | PHONE#: |
| PAYMENT TERMS: NET 30 | SHIPPING TERMS: FOB DESTINATION | E-MAIL: |
| SIGNATURE:            | PRINTED NAME & TITLE:           | DATE:   |

## 1. GENERAL OVERVIEW

### 1.1. University Information

The University is a state-supported research university located in Kentucky's largest metropolitan area. It was a municipally supported public institution for many decades prior to joining the university system in 1970. The University has three (3) campuses. The 287-acre Belknap Campus is three (3) miles from downtown Louisville and houses eight (8) of the university's twelve (12) colleges and schools. The Health Sciences Center (HSC) is situated in downtown Louisville's medical complex and houses the university's health-related programs and the University Hospital. The 243-acre Shelby-Hurst Campus located in eastern Jefferson County.

### 1.2. Mission Statement

The University pursues excellence and inclusiveness in its work to educate and serve its community through:

- Teaching diverse undergraduate, graduate, and professional students to develop engaged citizens, leaders, and scholars;
- Practicing and applying research, scholarship, and creative activity, and;
- Providing engaged service and outreach that improve the quality of life for local and global communities.

The University is committed to achieving preeminence as a premier anti-racist metropolitan research university.

### 1.3. Vision Statement

The University will be recognized as a great place to learn, a great place to work, and a great place in which to invest because we celebrate diversity, foster equity, and strive for inclusion.

## 2. PROPOSAL FORMAT AND REQUIREMENTS

### 2.1. Key Event Dates\*

|   |                                   |
|---|-----------------------------------|
| Release of RFP  | 02/27/2025                        |
| Pre-Proposal Conference <b>NOT MANDATORY</b><br>339 Byrne Ave, Louisville, KY 40209 | 03/06/2025 at 2:30 pm EST         |
| Deadline for Written Questions  | 03/12/2025 at 2:00 pm EST         |
| RFP Proposals Due   | 03/20/2025 at 2:00 pm EST         |
| Short List Announcement   | Week of 03/31/2025                |
| Offeror Presentations   | Week of 03/31/2025                |
| Letter of Intent to Negotiate Contract  | Week of 03/31/2025                |
| Desired Contract Effective Date   | Week of 04/09/2025                |
| <b>Substantial Completion of the Work</b>   | <b>June 27<sup>th</sup>, 2025</b> |

\*All dates are subject to change

### 2.2. Intent and Scope of Work

This proposal is for the removal of existing graphics and creation and installation interior design work for the Lynn Training Facility at Dr. Mark and Cindy Lynn Soccer Stadium. Located at 339 Byrne Ave, Louisville, KY 40209. This scope will include the entry way, main corridor, rotunda, team meal room, men's and women's lounges, women's locker room, recruiting lounge, and classroom. The scope of the renovation will include but is not limited to the following: fixture installation, architectural finishes, and wall graphic installation. All colors, designs, and finishes must be approved by ULA before installation.

The awarded contractor must provide all labor, materials, equipment, supervision, and permitting (if required) to complete the scope of work as detailed below.

#### Scope of Work:

- **Entry Way**
  - Provide and install dimensional lettering according to design package. **(Attachment A hereto.)**
- **Main Corridor**
  - Provide and install dimensional lettering according to design package.
- **Rotunda**
  - Provide and Install vinyl to windows according to design package.
  - Provide and install frosted vinyl to doors according to design package.
  - Provide and install dimensional signs/logos according to design package.

- Provide trophy display casework according to design package.
- Provide and install dimensional accents according to design package.
- **Recruiting Lounge Entry**
  - Provide Frosted Vinyl to door according to design package.
- **Women's Team Lounge**
  - Provide and install dimensional signs/lettering/graphic board according to design package.
- **Women's Locker Room**
  - Provide and install dimensional sign according to design package.
- **Team Dining**
  - Provide and install wall graphic according to design package.
- **Recruiting Lounge**
  - Provide and install wall graphic according to design package.
  - Provide and install dimensional lettering/logo according to design package.
  - Paint South Wall
  - Provide and install Silicone Edge Graphic (SEG) according to design package.
- **Classroom**
  - Provide and install dimensional lettering according to design package.
- **Men's Team Lounge**
  - Provide and install graphic board and acrylic and dimensional lettering according to design package.

**\*\*\*NOTE: Substantial Completion date for this project by June 27<sup>th</sup>, 2025. Final Completion July 9<sup>th</sup>, 2025**

### **2.3. Required Submittals**

The following list specifies the items to be addressed in the proposal. Offerors should read it carefully and address it completely, and in the order listed below, to facilitate the University's review of the proposal. Proposals shall be organized into the sections identified below.

- Signed Authentication of Proposal and Statement of Non-Collusion and Non-Conflict of Interest Form
- Executive Summary and Proposal Overview
- Transmittal Letter
- Offeror Qualifications – Criteria 1
- Services Defined – Criteria 2
- Financial Proposal – Criteria 3
- Evidence of Successful Performance and Implementation Schedule – Criteria 4
- Other Additional Information – Criteria 5

#### **2.3.1 Signed Authentication of Proposal and Statements of Non-Collusion and Non-Conflict of Interest Form**

The Offeror shall sign, completely and accurately, and return the Authentication of Proposal and Statements of Non-Collusion and Non-Conflict of Interest Form found on Page 2 of this solicitation. The person signing the offer must initial erasures or other changes. An offer signed by an agent is to be accompanied by evidence of their authority unless such evidence has been previously furnished to the purchasing authority. The signer shall further certify that the proposal is made without collusion with any other person, person, company, or parties submitting a proposal; that it is in all respects fair and in good faith without collusion or fraud; and that the signer is authorized to bind the principal Offeror.

#### **2.3.2 Executive Summary and Proposal Overview**

The Executive Summary and Proposal Overview shall condense and highlight the contents of the technical proposal in such a way as to provide the evaluation committee with a broad understanding of the entire proposal. The executive summary should include the following:

- When the organization was established and/or incorporated.
- Describe the size of the company in terms of number of employees, gross sales, etc.

#### **2.3.3 Transmittal Letter**

The transmittal letter accompanying the RFP shall be in the form of a standard business letter and shall be signed by an individual authorized to legally bind the Offer. It shall include:

- A statement referencing all addenda and written questions, the answers and any clarifications to this RFP issued by the University were received by the Offeror. If no addenda have been received or none were issued, a statement to that

- effect should be included.
- A statement that the Offeror's proposal shall remain valid for six (6) months after the closing date of the receipt of the proposals.
- A statement that the Offeror will accept financial responsibility for all travel expenses incurred for oral presentations (if required) and/or candidate interviews.
- A statement that summarizes any deviations or exceptions to the RFP requirements or the terms and conditions (Section 5) of the RFP. A detailed justification for the deviation or exception, and a list of exceptions or additions to the RFP terms and conditions should be provided. **Any deviations or exceptions not addressed in the transmittal letter may not be considered in any resulting contract.**
- A statement that identifies any confidential or proprietary information should be provided.

#### **2.3.4 Criteria for Evaluation**

##### **2.3.4.1 Criteria 1 – Offeror Qualifications**

The purpose of the Offeror Qualifications section is to determine the ability of the Offeror to respond to this RFP. Offerors must describe and offer evidence of their ability to meet each of the qualifications listed below:

- Provide a brief narrative describing your firm and its ability to meet the requirements as defined in the Scope of Work in Section 2.2. Offeror shall be experienced and knowledgeable in their industry and be able to determine and communicate how it will provide the goods and/or services requested in Section 2.2 to best meet the needs of the University.
- Offerors shall have one or more designated representatives to the University account. Describe your firm's approach and indicate the individual and/or team that will be responsible for the account. Include a description of the representative(s) background and experience as related to the requested good and/or services.
- If the Offeror has had a contract terminated for default in the last five (5) years, describe such incident. Submit full details for the default, including the other parties' name, address, and telephone number. Present the Offeror's position on the matter. The University will evaluate the facts and may, at its sole discretion, reject the proposal on the grounds of experience. If the Offeror has experienced no such termination for default in the past five (5) years, so indicate.
- Has the Offeror's company ever filed for bankruptcy, had a receiver appointed, made, or consented to an assignment for the benefit of creditors, been in loan default, currently have any pending liens, claims, or lawsuits against the company? If so, please describe.
- Describe any additional qualifications your company offers that may be beneficial to the University for evaluation purposes of this RFP.

##### **2.3.4.2 Criteria 2 - Services Defined**

Offerors shall describe and offer evidence of their ability to meet the services as requested in Section 2.2

- Provide a description of the plan of providing, implementing (including timeline), maintaining services requested. How will your company partner with the University to best meet our needs?
- Provide a description of your firm's procedure to address customer service issues, potential delays in deliveries or implementation timeline, or any other issue that may arise during the agreement period, if awarded.
- What steps would be taken if the quality of the product or service does not meet the quality standards of the end user?
- Provide other information that may be pertinent to this RFP, represent best practices, streamlined or more efficient processes, etc. for the University to consider.

##### **2.3.4.3 Criteria 3 - Financial Proposal**

Offerors shall provide a detailed proposal of all costs that will be incurred by the University for this project.

Financial Proposal for goods and services should remain consistent, with no increases.

Financial proposal shall include, but not be limited to, detail as follows if applicable to the project. Lump sum only amounts for a financial proposal will not be considered.

- Position title performing service (e.g., engineer, data analyst, etc.).
- Hourly rate of service provided.
- Total number of hours billed.
- Milestones or Phases - what the cost for each portion of the project?
- All fees (maintenance, delivery, etc.)
- How will the University be billed? Monthly, quarterly, at completion, as milestones are completed. Example: Monthly billing at \$XX.XX for XX months.

##### **2.3.4.4 Criteria 4 - Evidence of Successful Performance and Implementation Schedule**

The purpose of this section is to determine the capability of the Offeror to provide the services and/or goods requested in Section 2.2 of this RFP. Offerors must describe and offer evidence to meet each of the qualifications below:

- Describe similar work in the past five (5) years where your firm has provided like type goods and/or services requested in this RFP to clients that are similar in size and nature to the University (e.g., public service clients, educational institutions, and/or healthcare clients). Include specific examples of how your company's efforts resulted in exceptional performance and customer service.
- Provide at least three (3) references with contact name, phone number and email address of clients for whom you have provided similar goods or services as requested in this RFP. By providing reference information, Offeror permits the University to contact the references. References provided should be non-University of Louisville clients.

**2.3.4.5 Criteria 5 – Other Additional Information**

Please provide any additional information that the Offeror feels should be considered when evaluating the proposal submitted. The Offeror may present any creative approaches that might be appropriate. The Offeror may also provide supporting documentation that would be pertinent to this RFP.

**3 EVALUATION CRITERIA PROCESS**

A committee of University officials appointed by Procurement Services will evaluate proposals and make a recommendation to Procurement Services. The evaluation will be based upon the information provided in the proposal, additional information requested by the University for clarification, information obtained from references provided and independent sources, and oral presentations (if requested).

The evaluation of responsive proposals shall be completed by an evaluation team, which will determine the ranking of proposals. Proposals will be evaluated strictly in accordance with the requirements set forth in this solicitation, including any addenda that are issued. The University will award the contract to the Offeror whose proposal is determined to be the most advantageous to the University, taking into consideration the evaluation factors set forth in this RFP.

The evaluation of proposals received will include consideration or responses to the list of criteria defined in Section 2.3.4. Offerors must specifically address all criteria in their response. Any deviations or exceptions to the specifications, requirements, or terms and conditions in this RFP must be addressed in the transmittal letter. Failure to provide a response to all criteria in Section 2.3.4 or to list any deviations or exceptions may be considered sufficient reason to reject the proposal.

The relative importance of the criteria is defined below:

**PRIMARY CRITERIA**

|   |      |
|---|------|
| Offeror Qualifications                                | 25%  |
| Services Defined                                      | 25%  |
| Financial Proposal                                    | 30%  |
| Evidence of Successful Performance and Implementation | 20%  |
| Total   | 100% |

**SECONDARY CRITERIA**

|                           |
|---------------------------|
| Other Additional Services |
|---------------------------|

The University will evaluate proposals as submitted and may not notify Offerors of deficiencies in their responses.

**Proposals must contain responses to each of the criteria listed in Section 2.3.4 even if the Offeror's response cannot satisfy those criteria. A proposal may be rejected if it is conditional or incomplete in the judgement of the University.**

**4 INSTRUCTIONS TO PROPOSERS**

**4.3 Offeror Communication**

To ensure that RFP documentation and subsequent information (modifications, clarifications, addenda, written questions, and answers, etc.) are directed to the appropriate persons within the Offeror's firm, each Offeror who intends to participate in this RFP is to provide the following information to the Contract Administrator of record. Prompt, thorough compliance is in the best interest of the Offeror. Failure to comply may result in incomplete or delayed communication of addenda or other vital information. Contact information is the responsibility of the Offeror. Without the prompt information, any communication shortfall shall reside with the Offeror.

- Name of primary contact
- Mailing address of primary contact
- Telephone number(s) of primary contact
- Email address of primary contact
- Additional contact persons with same information provided as primary contact

This information shall be transmitted by email to:  
Jamie Peck  
[Jamie.peck@louisville.edu](mailto:Jamie.peck@louisville.edu)  
University of Louisville, Procurement Services  
2215 S Brook St.  
Louisville, KY 40292

All communication with the University regarding this RFP shall **ONLY** be directed to the contracting officer listed above. **Failure to do so may result in disqualification of submitted proposal.**

#### **4.4 Offeror Presentations**

All Offerors whose proposals are judged acceptable for award may be required to make a presentation to the evaluation committee.

#### **4.5 Preparation of Offers**

The Offeror is expected to follow all specifications, terms, conditions, and instructions in this RFP. The Offeror will furnish all information required by this solicitation.

Proposals should be prepared simply and economically, providing a description of the Offeror's capabilities to satisfy the requirements of the solicitation. Emphasis should be on completeness and clarity of content. All documentation submitted with the proposal should be bound in the single volume except as otherwise specified.

An electronic version of the RFP, in PDF format only, is available through the University Procurement Services website found here: [University of Louisville Active Solicitations](#)

#### **4.6 Proposed Deviations from the RFP**

Any deviations therefrom must be specifically defined in accordance with the transmittal letter, Section 2.3.3. If accepted by the University, the deviations shall become part of the contract, but such deviations must not conflict with the basic nature of this RFP.

Deviations, modifications, or exceptions to any terms in this solicitation not included in the transmittal letter shall not be accepted in any resulting contract.

**Note: Offerors shall not submit their standard terms and conditions as exceptions to the University's terms and conditions. Each exception to the University's terms and conditions addressed in the transmittal letter shall be individually addressed.**

#### **4.7 Proposal Submission and Deadline**

Offeror must provide the following information to the Contract Administrator of record in Section 4.3 by **email (preferred)**, UPS, FedEx, or USPS prior to the date and time specified in Section 2.1. Proposal documents should be clearly labeled with the solicitation number.

- Technical proposal
- Financial proposal

**Note: Proposals received after the closing date and time indicated in Section 2.1 will not be considered, without exception.**

#### **4.8 Competitive Negotiation**

It is the intent of the University to enter competitive negotiation for this RFP as authorized by KRS [45A.085](#) and as such there will be no public opening.

A contract will be awarded to the Offeror whose proposal conforms to the terms, conditions and scope of this RFP and is deemed by the University as offering the best value to the University, with price and other evaluation factors considered as indicated in Section 2.3.4.

Prior to contract award, Procurement Services shall complete a review of the Supplier(s) against appropriate governmental exclusion/debarment/suspension lists. Any Suppliers who are identified as potential matches will be reported to the Institutional Compliance Office for verification procedures prior to contract award. Procurement Services will not proceed with a contract award to any Supplier verified as a positive match, without consultation with the Institutional Compliance Office and appropriate University Administration.

The University reserves the right to reject any or all offers and to waive informalities and minor irregularities in offers received.

It is the University's intent to award a single contract. The University reserves the right to change this intent and award multiple contracts if deemed in the best interest of the University.

#### **4.9 Appearance Before Committee**

Any, all, or no Offerors may be requested to appear before the evaluation committee to explain their proposal and/or to respond to questions from the committee concerning the proposal. Offerors are prohibited from electronically recording these meetings. The committee reserves the right to request additional information.

#### **4.10 Modification or Withdrawal of Proposal**

A proposal and/or modification of proposal received at the office designated in the solicitation after the exact hour and date specified for receipt will not be considered.

A proposal may be modified or withdrawn by written notice before the exact hour and date specified for receipt of offers. A proposal also may be withdrawn in person by an Offeror or an authorized representative, provided the identity of the person is made known and the person signs a receipt for the offer, but only if the withdrawal is made prior to the exact hour and date set for receipt of offers.

#### **4.11 Acceptance or Rejection and Award of Proposal**

The University reserves the right to accept or reject any or all proposals (or parts of proposals), to waive any informalities or technicalities, to clarify any ambiguities in proposals and (unless otherwise specified) to accept any item in the proposal. In case of error in extension or prices or other errors in calculation, the unit price shall govern. Further, the University reserves the right to make a single award, split awards, multiple awards, or no award, whichever is in the best interest of the University.

#### **4.12 Rejection**

Grounds for the rejection of proposals include, but shall not be limited to:

- Failure of a proposal to conform to the essential requirements of the RFP.
- Imposition of conditions that would significantly modify the terms and conditions of the solicitation or limit the Offeror's liability to the University on the contract awarded based on such solicitation.
- Failure of the Offeror to sign the University RFP. This includes the Authentication of Proposal and Statement of Non-Collusion and Non-Conflict of Interest statements.
- Receipt of proposal after the closing date and time specified in Section 2.1

#### **4.13 Addenda**

Any addenda or instructions issued by Procurement Services prior to the deadline for receiving proposals shall become a part of this RFP. Such addenda shall be acknowledged in the proposal. No instructions or changes shall be binding unless document by a proper and duly issued addendum.

#### **4.14 Disclosure of Offeror's Response**

The RFP specifies the format, required information, and general content of proposals submitted in response to this RFP. The purchasing agency will not disclose any portions of the proposals prior to contract execution to anyone outside the University's Department of Procurement Services, the University's administrative staff, representatives of the state or federal government (if required) and the members of the committee evaluating the proposals. After a contract is fully executed, in whole or in part, the University shall have the right to duplicate, use, or disclose all proposal data submitted by Offerors in response to this RFP as a matter of public record.

Any submitted proposal shall remain valid for six (6) months after the proposal due date.

The University shall have the right to use all system ideas, or adaptations of those ideas, contained in any proposal received in response to this RFP. Selection or rejection of the proposal will not affect this right.

#### **4.15 Restrictions on Communications with University Staff**

From the issue date of this RFP until a supplier is selected and contract is fully executed, Offerors are not allowed to communicate about the subject of this RFP with any University administrator, faculty, staff or members of the Board of Trustees except for: the procurement services representative, any University contracting official representing the University administration, any other individuals authorized in writing by Procurement Services and University representatives during Offeror presentations. If this provision is violated, the University reserves the right to reject the Offeror's proposal.

#### **4.16 Bid Protest**

([KRS 45A.285](#) [KRS 164A.555](#) to [KRS 164A.630](#))

Any Bidder or prospective Bidder, Offeror, or Supplier who is aggrieved in connection with the solicitation or selection of award of a contract by the University, may file a protest via Certified Mail, addressed to the Director of Procurement Services, within two (2) calendar weeks after such aggrieved person knows or should have known the facts giving rise thereto. An up to date posting of current awards can be found at [University of Louisville Awarded Bids](#). All protests must be in writing and must use the phrase "Bid Protest" in the letter. The Chief Procurement Officer shall review all facts presented and render a determination, in writing, promptly to the aggrieved person.



The aggrieved person may appeal the determination in writing via Certified Mail within four (4) calendar days, addressed to the Executive Vice President of Finance and Administration (EVP F&A), who shall promptly issue a ruling in writing. A copy of such appeal must also be sent via Certified Mail to the EVP F&A designee. The ruling of the EVP F&A shall be the final action on behalf of the University.

In the event of a bid protest, the University may notify the successful Bidder to suspend the contract/order while the protest is being reviewed. Depending on the outcome of the protest, the contract/order may be cancelled or confirmed. Any questions regarding this procedure should be addressed to the Director of Procurement Services at (502) 852-7211.

#### **4.17 Cost of Preparing Proposal**

The University shall not, in any event, be liable for any pre-contractual expenses incurred by the Offeror in the preparation of their proposal. Offeror shall not include any such expenses as part of their proposal.

Pre-Contractual expenses are defined as:

- All expenses incurred by the Offeror in the preparation of the proposal in response to this solicitation.
- All expenses incurred by the Offeror in submitting that proposal to the University.
- All expenses incurred by the Offeror while negotiating with the University for any matter related to this proposal (such as travel expenses, etc.)
- Any other expenses incurred by the Offeror prior to the effective date of the contract.

#### **4.18 Disposition of Proposals**

All proposals become the property of the University. The successful proposal will be incorporated into the resulting contract.

#### **4.19 Questions**

All questions must be submitted in writing by email to the Contract Administrator listed in Section 3.1 no later than the date listed in Section 2.1 to receive an official response which will be posted by addendum. Any questions not submitted in writing will not be considered part of the official response.

#### **4.20 Section Titles in the RFP**

Section titles used herein are for the purpose of facilitating ease of reference only and shall not be construed to infer the construction of contractual language.

#### **4.21 No Contingent Fees**

No person or selling agency shall be employed or retained or given anything of monetary value to solicit or secure this contract, except bona fide employees of the Offeror or bona fide established commercial or selling agencies maintained by the Offeror for the purpose of securing business. In the event of a breach of violation of this provision, the University shall have the right to reject the proposal, annul the contract without liability, or at its discretion, deduct from the contract price or otherwise recover the full amount of such commission, percentage, brokerage, or contingent fee or other benefit.

## **5 TERMS AND CONDITIONS**

### **5.1 Contract Term**

The contract resulting from this RFP shall be effective from the date of execution (date of last signature) until final completion of the Work in section 2.2. Contract renewal may be considered at the end of the initial contract term, at the sole discretion of the University, based on performance of awarded supplier. Any contract renewal shall be executed upon mutual agreement and documented in writing by Addendum.

### **5.2 Additions, Deletions, or Contract Changes**

The University reserves the right to add, delete, or change related items or services to the contract established from this RFP. No modification or change of any provision in the resulting contract shall be made unless such modification is mutually agreed to in writing by the Supplier and Procurement Services and incorporated as a written modification in the form of an amendment to the contract. Memoranda of understanding and other correspondence, verbal and written, shall not be interpreted as a modification to the contract.

### **5.3 Contractor Cooperation in Related Efforts**

The University reserves the right to undertake or award other contracts for additional or related work to other entities. The Supplier shall fully cooperate with such other Suppliers and University employees and carefully fit its work to such additional work. The Supplier shall not commit or permit any act which will interfere with the performance of work by any other Supplier or by University employees. This clause shall be included in the contract of all Suppliers with whom this Supplier will be required to cooperate. The University shall equitably enforce this clause to all Suppliers to prevent the imposition of unreasonable burdens on any Supplier.

### **5.4 Compliance with Kentucky Campaign Law**

The Offeror representative certifies that neither he/she/they, nor any member of his/her/their immediate family, having an interest

of 10% or more in any business entity involved in the performance of any resulting contract of this solicitation, has contributed more than the amount specified in [KRS 121.056 \(2\)](#) to the campaign of the gubernatorial candidate elected at the election preceding the date of any resulting agreement of this solicitation. The signee further sears under the penalty of perjury, that neither he/she/they or the supplier which he/she/they represents, has knowingly violated any provision of the campaign laws of the Commonwealth of Kentucky, and that the award of a contract to him/her/they or the supplier which he/she/they represents will not violate any provision of the campaign finance laws of the Commonwealth of Kentucky.

#### **5.5 Governing Law**

The Supplier shall conform to and observe all laws, ordinance, rules, and regulations of the United States of America, Commonwealth of Kentucky, and all other local governments, public authorities, boards, or offices relating to the property or the improvements upon same (or the use thereof) and will not permit the same to be used for any illegal or immoral purpose, business, or occupation. The resulting contract shall be governed by Kentucky law and any claim relating to this contract shall only be brought in the Franklin Circuit Court, Frankfort, Kentucky in accordance with [KRS 45A.245](#).

#### **5.6 Americans with Disability Act (ADA) Compliance**

When applicable (e.g., webpages), the supplier's products and services will be in compliance with the current ADA requirements including, but not limited to, the applicable current ADA Standards for Acceptable Design, WCAG 2.1, Section 508 of the Rehabilitation Act of 1973, as amended (29 U.S.C. 794), Section 255 of the Communications Act, as amended and applicable regulations.

#### **5.7 Treatment of University Data/Information**

If the SUPPLIER is provided access or is provided copy(ies) of UNIVERSITY data, the SUPPLIER agrees to secure and protect the UNIVERSITY data (and require the same of any other entity with whom it shares or gives access to UNIVERSITY data) from unauthorized access, use, modification, disclosures, manipulation, or destruction, and that it will use processes that meet industry standard practices for protecting a customer's information (which standards shall be at least as stringent as the SUPPLIER would use for protecting its own confidential information). SUPPLIER agrees to notify the UNIVERSITY of a security breach/security incident as specified at [University of Louisville Security Incident Reporting](#) relating to UNIVERSITY data that SUPPLIER or its agents or subcontractors has access to or is in their possession within seventy-two (72) hours of discovery of an actual or suspected breach. SUPPLIER agrees to cooperate with the UNIVERSITY in complying with the response, mitigation, correction, and notification efforts, including undertaking a prompt and reasonable investigation of any such incident. Upon termination or cancellation of this AGREEMENT between the UNIVERSITY and SUPPLIER, all data, including disks, tapes, and electronic files in the possession of SUPPLIER or its agents, subcontractors, or other third party will be destroyed unless: (1) SUPPLIER is required to retain such data pursuant to applicable law; or (2) the individual to whom the data relates request that SUPPLIER maintain its data in accordance with applicable privacy or other legal requirement(s). ("Required Copy(ies)"). Any such Required Copy(ies) will be kept secure and the duty of notification of a breach/incident will continue. The UNIVERSITY acknowledges that such data communicated and/or stored in electronic form may be routinely backed up such that return, or destruction is not practicable and/or feasible, in which case SUPPLIER (or its subcontractors/agents/others with whom the information has been shared) will keep such back-up copies secure until the back-up media is recycled or destroyed.

**General Data Protection Regulation (GDPR) Personal Data.** To the extent SUPPLIER processes personal data (Article 4) or sensitive personal data (Article 9) as defined in the [European Union GDPR](#) effective May 25, 2018, SUPPLIER, to the extent applicable, (i) shall take all measures required pursuant to Article 32 of GDPR and the SUPPLIER shall implement appropriate technical and organizational measures to ensure a level of security appropriate to the risk; (ii) shall ensure that only authorized individuals are able to access the personal data being processed on behalf of the UNIVERSITY; (iii) shall not engage another entity (Sub-Processor) without the prior specific or general written consent of the UNIVERSITY; (iv) shall notify UNIVERSITY of a security breach as specified at [University of Louisville Security Incident Reporting](#) relating to personal information in the possession of SUPPLIER or its agents or subcontractors within seventy-two (72) hours of discovery of an actual or suspected breach; (v) shall cooperate with UNIVERSITY in complying with the response, mitigation, correction, investigation, and notification requirements, including undertaking a prompt and reasonable investigation of any security breach; and (vi) paying those costs of notification, investigation, and mitigation in the event of a security breach of personal data, to the extent, cause by the actions or inactions of SUPPLIER. As an agency of the Commonwealth of Kentucky, the UNIVERSITY confirms that it cannot agree to be bound by or submit to the jurisdiction or laws of another government and, therefore, cannot enter into the standard contractual clauses required pursuant to Article 45 of GDPR (EU) 2016/679 for international transfers of personal data outside of the European Economic Area or to a country not recognized by the European Commission as being in adequation. As a result, SUPPLIER shall be solely responsible for compliance with GDPR, if applicable, including but not limited to obtaining any necessary written consents.

#### **5.8 Prime Contractor Responsibility**

Any contract(s) that may result from this solicitation shall specify that the Supplier(s) is/are solely responsible for fulfillment of the contract with the University.

**5.9 Permits, Licenses, Taxes**

The Offeror awarded a contract from this solicitation shall procure all necessary permits and licenses and abide by all applicable laws, regulations, and ordinances of all federal, state, and local governments in which work under the resulting contract is performed.

The Offeror must furnish certification of authority to conduct business in the Commonwealth of Kentucky as a condition of contract award. Such registration is obtained from the Secretary of State, who will also provide the certification thereof. However, the Offeror need not be registered as a prerequisite for responding to this solicitation.

Any Offeror awarded a contract from this solicitation shall pay any sales, use, personal property, and other tax arising out of this contract and the transaction completed hereby. Any other taxes levied upon the resulting contract, the transaction, equipment, or services delivered pursuant hereto shall be the responsibility of the awarded Supplier.

The awarded Supplier will be required to accept liability for payment of all payroll taxes or deductions required by local and federal law (but not limited to) old age pension, social security, or annuities.

**5.10 F.O.B. Destination**

All Offers in response to this solicitation must be based on F.O.B. to the University, all freight prepaid and included in the unit price. No other terms are acceptable; any Offers that do not comply with the above will be rejected. The Supplier will be fully responsible for all items while in transit, including returns. Any freight claims will be the responsibility of the Supplier.

Large scale products may require delivery to specific building locations. Offerors shall be required to make inside building deliveries if required within the RFP specifications.

**5.11 Indemnification**

Indemnification by the University to indemnify the Supplier or any of its subcontractors or otherwise shall only be to the extent permitted by Kentucky Revised Statutes (KRS [49.010](#) through [49.180](#)) by the powers and authority vested in the Kentucky Claims Commission and KRS [45A.225](#) through [45A.275](#) (Contract Claims). University does not waive any of the rights, privileges or immunities available to Kentucky state agencies, and any conflicting provision in the terms and conditions or agreement provided by the vendor is rejected.

Any Supplier awarded a Contract as a result of this solicitation shall defend, indemnify, and hold harmless the University, its affiliated entities, their trustees, officers, employees, and agents from and against all costs, losses, and expenses (including reasonable cost of attorneys' fees) by reason of liability imposed by law upon the Supplier for damages resulting from the Supplier's performance or because of bodily injury, including death, personal injury, data breach/loss at any time resulting there from, sustained by any person or persons including the Supplier's employees, or on account of damage to property, including loss of use thereof, to the extent arising out of or in consequence of the negligent or intentional action or omission, or willful misconduct of the Supplier, provided however, that nothing contained herein shall require the Supplier to indemnify the University for such injuries to persons or damage to property to the extent arising out of, or in consequence to the negligent or intentional action, omission, or willful misconduct of the University, its officers, employees, and agents. Any cap or limitation on the amount of the liability included in its response is rejected. Any limitation of liability requires specific acceptance by the University (e.g., via an amendment signed in writing by both parties).

**5.12 No Arbitration**

Binding arbitration to resolve a controversy or claim arising out of or relating to this contract, or breach thereof, is expressly rejected and may not be sought by either party hereto. Mediation or other forms of non-binding alternative dispute resolution may be used in lieu of binding arbitration.

**5.13 Insurance Requirements**

Before the supplier becomes entitled to any rights under this procurement and prior to taking any action under any resulting award/agreement, supplier shall have a Certificate of Insurance indicating the organization's in-force insurance coverage for the following policies and limits. Supplier agrees to provide proof of insurance upon request.

**MINIMUM COVERAGE AMOUNTS**

| Type of Insurance   | Minimum Limits of Liability  |
|---|--|
| <b>Commercial General Liability*</b><br>Including: Completed Products, Personal and Advertising Injury, Products/Completed Operations | \$1,000,000.00 Each Occurrence<br>\$2,000,000.00 General Aggregate       |
| <b>Auto Liability*</b><br>All owned, hired, and non-owned vehicles  | \$1,000,000.00 Combined Single Limit<br>(Bodily Injury, Property Damage) |

|                               |  |
|-------------------------------|--|
| <b>Workers' Compensation</b>  | Statutory Limits – Kentucky and the state(s) of domicile of the organization and any subcontractor(s). The all state and voluntary compensation endorsement is to be attached to the policy. |
| <b>Employers' Liability</b>   | \$1,000,000.00<br>(Each employee, each accident and policy limit)  |
| <b>Professional Liability</b> | \$1,000,000.00 Each Occurrence<br>\$1,000,000.00 General Aggregate   |
| <b>Property Insurance</b>     | Replacement Cost, Open Perils, Property Insurance for all Personal Property used/stored by the supplier involved procurement on University Property.   |

\*Occurrence coverage is required. Claims-made coverage is not acceptable.

These policies (except Workers' Compensation) shall name the University, its trustees, officers, employees, and agents as Additional Insured and shall contain a covenant requiring no less than then (10) business days written notice to the University before cancellation, reduction, or other modification of coverages.

These policies shall be primary and noncontributing with any insurance carried by the University and shall contain a severability of interest clause in respect to cross liability, protecting each Additional Insured as though a separate policy had been issued to each. A certificate of the above policies shall be furnished to the University at least then (10) business days prior to the commencement of the services provided under this agreement.

All Certificates of Insurance must clearly state that the organization's insurance is PRIMARY. If organization's policy has deductibles, self-insured retentions, or co-insurance penalties, then all such costs shall be solely borne by the organization and not by the University. The University will not share in any policy deductibles.

It is hereby agreed that in event of a claim arising under this policy, the organization will not deny liability by reason of the Additional Insured being a state, county, municipal corporation, or governmental agency.

The limits listed above may be accomplished through a combination of primary and excess/umbrella liability policies written on a "follow form" basis or forms no more restrictive than the primary policies.

#### **5.14 Reciprocal Preference**

In accordance with [KRS 45A.494](#) a resident Offeror of the Commonwealth of Kentucky shall be given a preference against a nonresident Offeror. In evaluating proposals, the University will apply a reciprocal preference against an Offeror submitting a proposal from a state that grants residency preference equal to the preference given by the state of the nonresident Offeror. Residency and non-residency shall be defined in accordance with [KRS 45A.494\(2\)](#) and [KRS 45A.494\(3\)](#), respectively.

Any Offeror claiming Kentucky residency status shall submit with its proposal a notarized affidavit ([Resident Bidder Status Form](#)) affirming that it meets the criteria as set forth in the above referenced statute. ***This condition does not apply to procurements utilizing Federal funds.***

#### **5.15 Sustainability**

The University is dedicated to acquiring products and services that are consistent with our commitment to sustainability. For the purpose of judging sustainability, the following considerations apply:

Sustainable Development is enhanced through sound Environmental, Social, and Economic practices and technologies that minimize or eliminate waste and negative impacts on current resources.

The University seeks products and services that pose no significant risk to human health or environmental quality when compared with competing products or services that serve the same purpose. This comparison, where applicable, may consider raw materials and energy acquisition; production and manufacturing; packaging and distribution; and the operation, maintenance, reuse, recyclability, or disposal of a product. Materials, products, and workers from the local region are preferred sources, along with companies/contractors that can demonstrate efforts to ensure worker protections and to restore or enhance the environment.

#### **5.16 Confidentiality**

The University recognizes an Offeror's possible interest in preserving selected information and data included in the proposal; however, the University must treat such information and data as required by the Kentucky Open Records Act, KRS [61.870](#), et seq.

Information areas which normally might be considered proprietary, and therefore confidential, shall be limited to individual personnel data, customer references, formulae, and company financial audits which, if disclosed, would permit an unfair

advantage to competitors. If a proposal contains information in these areas and the Offeror declares that information to be proprietary in nature and not available for public disclosure, the Offeror shall declare in the Transmittal Letter the inclusion of proprietary information and shall noticeably label as confidential or proprietary each sheet containing such information. Proposals containing information declared by the Offeror to be proprietary or confidential, either wholly or in part, outside the areas listed above may be deemed non-responsive and may be rejected.

The University's General Counsel shall review each Offeror's information claimed to be confidential and, in consultation with the Offeror (if needed), make a final determination as to whether the confidential or proprietary nature of the information or data complies with the Kentucky Open Records Act.

#### **5.17 Conflict of Interest**

Any Offeror responding to the RFP is required to disclose any potential conflict of interest. If the owner of the organization is related to a University employee, that relationship must be disclosed in writing and made part of the proposal response.

For the purposes of disclosure of a conflict, a person is a related person if related to a University employee in any of the following ways, and includes those within these categories who are referred to as adopted, step-, foster, grand-, half-, in-law, spouse of, or great-:

- Parent
- Child or Ward
- Sibling
- Uncle or Aunt
- First cousin
- Nephew or niece
- Spouse, domestic partner, significant other

#### **5.18 University Brand Standards**

The Supplier must adhere to all University Brand Standards when using University logos, trademarks, or other University intellectual property. University Brand Standards are maintained by the University Office of Communications and Marketing (OCM) and can be viewed [here](#). Use of University Brand Standards must be approved in writing by the Office of Communications and Marketing prior to a contract being awarded. Non-adherence to the standards can have a penalty up to and including contract cancellation. Only the OCM Director or designee can approve exceptions to the University standards.

#### **5.19 Payment Terms**

The Supplier shall be paid, within thirty (30) days after receipt of a proper invoice sent to the University Controller's Office, at the prices stipulated for items delivered and accepted, or services rendered. Unless otherwise specified, payment will not be made in advance, or for partial deliveries.

The University reserves the right to make payment for orders via the University corporate Visa procurement card (ProCard).

#### **5.20 Tax Exempt Status**

The University is tax exempt from the provision of the Kentucky six percent (6%), sales and/or Use Tax on materials and equipment under this procurement. The University is also entitled to exemption from Federal Excise Tax. Our tax-exempt number is C-102. Exemption certifications shall be furnished upon request to cover exemptions where applicable.

#### **5.21 COVID-19 Safety Requirements**

Offerors, awardees, their subcontractors, and all associated personnel, while on any University property or University controlled property, must be in compliance with all current University, state, local, and/or federal public health guidance for the prevention of spread of COVID-19. These guidelines include, but are not limited to, practicing social distancing to the extent practicable, and wearing a mask that covers both the individual's nose and mouth.

- Further details regarding the University COVID-19 safety procedures can be found here: [University COVID-19 Response](#)
- Current CDC guidelines can be found here: [CDC Guidelines](#)
- Current Kentucky COVID-19 Resources can be found here: [KY COVID-19 Resources](#)

### **6 SUPPLIER CERTIFICATION**

The following certifications and acknowledgements are applicable as indicated by the particular provision.

The term "Supplier", as used in this section, refers to the entity that is supplying the goods or services to the University or one of its affiliated corporations. In related documents, the entity may also be referred to as Bidder, Offeror, Applicant, Proposer, Seller, Second Party, Subcontractor, or similar term.

The term "Contract", as used in this section, refers to the agreement, purchase order, memorandum of understanding, subcontract, subaward, personal services agreement/contract or other similar document specifying the provisions under which the Supplier is providing goods or services to the University or one of its affiliated corporations.

The term "University affiliated entity" refers to the University of Louisville, the University of Louisville Research Foundation, Inc., or the University of Louisville Athletic Association.

#### **6.1 Equal Opportunity Clause**

*(Applicable to Suppliers exceeding \$10,000 in Contracts with a University affiliated entity in a twelve-month period)*

This Contract is subject to the requirements of Executive Orders 11246 and 11375 and the rules and regulations of the U.S. Secretary of Labor (41 CFR Chapter 60) in promoting Equal Opportunities.

During the performance of this Contract the Supplier agrees as follows:

- i. Supplier will not discriminate against any employee or applicant for employment because of race, religion, color, sex, or national origin. Supplier will take affirmative action to ensure that applicants are employed, and that employees are treated during employment without regard to their race, religion, color, sex, or national origin. Such action shall include, but not be limited to, the following: employment, upgrading, demotion, or transfer; recruitment or recruitment advertising; layoff or termination; rates of pay or other forms of compensation, and selection for training, including apprenticeship. Supplier agrees to post in conspicuous places, available to employees and applicants for employment, notices to be provided by the Government setting forth the provisions of this nondiscrimination clause.
- ii. Supplier will, in all solicitations or advertisements for employees placed by or on behalf of the Supplier, state that all qualified applicants will receive consideration for employment without regard to race, religion, color, sex, or national origin.
- iii. Supplier will send to each labor union or representative of workers with which he has a collective bargaining agreement or other contract or understanding, a notice advising the labor union or workers' representative of Supplier's commitments under Section 202 of Executive Order 11246 of September 24, 1965, as amended, and shall post copies of the notice in conspicuous places available to employees and applicants for employment.
- iv. Supplier will comply with all provisions of Executive Order 11246 of September 24, 1965, as amended, and of the rules, regulations, and relevant orders.
- v. Supplier will furnish all information and reports required by Executive Order 11246 of September 24, 1965, and by the rules, regulations, and orders, or pursuant thereto, and will permit access to his books, records, and accounts by the contracting agency and the Affirmative Action Office for the purposes of investigation to ascertain compliance with such rules, regulations, and orders.
- vi. In the event of Supplier's noncompliance with the nondiscrimination clauses of this Contract or with any of such rules, regulations, or orders, this Contract may be cancelled, terminated, or suspended in whole or in part, and Supplier may be declared ineligible for further Government contracts in accordance with the procedures authorized in Executive Order 11246 of September 24, 1965, and such other sanctions may be imposed or remedies invoked as provided in Executive Order 11246 of September 24, 1965, or by rule, regulation, or order of the Secretary of Labor, or as otherwise provided by law.
- vii. Supplier will include the provisions of Paragraphs (i) through (vi) in every subcontract or purchase order unless exempted by the rules, regulations, or orders issued pursuant to Section 204 of Executive Order 11246 of September 24, 1965, so that such provision will be binding upon each subcontractor or vendor. Supplier will take such action with respect to any subcontract or purchase order as the Government or Buyer may direct as a means of enforcing such provision including sanctions for noncompliance; provided, however, that in the event Supplier becomes involved in, or is threatened with, litigation with a subcontractor or vendor as a result of such direction, Supplier may request the United States to enter into such litigation to protect the interests of the United States.

#### **6.2 Affirmative Action for Disabled Veterans and Veterans of the Vietnam Era**

*(Applicable to Suppliers exceeding \$10,000 in Contracts with a University affiliated entity)*

This Contract is subject to the requirements of Executive Order 11701 and the regulations of the U.S. Secretary of Labor (41 CFR Chapter 60, Part 60-250) in promoting employment opportunities for disabled and Vietnam veterans.

During the performance of this contract or purchase order, Supplier agrees as follows:

- i. To provide special emphasis to the employment of qualified disabled veterans and veterans of the Vietnam era. The Supplier also agrees that all suitable employment openings of the Supplier which exist at the time of execution of this Contract and those which occur during the performance of this Contract, including those not generated by this Contract and including those occurring at an establishment of the Supplier other than the one wherein the Contract is being performed but excluding those of independently operated corporate affiliates, shall be offered for listing at an appropriate local office of the State Employment Service system wherein the opening occurs and to provide such

reports to such local office regarding employment openings and hires as may be required: provided, that if the Contract or purchase order is for less than \$10,000 or if it is with a state or local government, the reports set forth in Paragraphs (iii) and (iv) of this clause are not required.

- ii. Listing of employment openings with the employment service system pursuant to this clause shall be made at least concurrently with the use of any other recruitment service or effort and shall involve the normal obligations which attach to the placing of a bona fide job order, including the acceptance of any particular job applicant or from any particular group of job applicants, and nothing herein is intended to relieve the Supplier from any requirements in Executive Order or regulations regarding nondiscrimination in employment.
- iii. The reports required by Paragraph (i) of this clause shall include, but not be limited to, periodic reports which shall be filed at least quarterly with the appropriate local office or where the Supplier has more than one establishment in a state, with the central office of the state employment service. Such reports shall indicate for each establishment (1) the number of individuals who were hired during the reporting period; (2) the number of those hired who were disabled veterans; and (3) the number who were nondisabled veterans of the Vietnam era.
- iv. The Supplier shall submit a report within thirty (30) days after the end of each reporting period wherein any performance is made on this contract or purchase order. The Supplier shall maintain copies of the reports submitted until the expiration of one year after final payment under the Contract, during which time they shall be made available, upon request, for examination by any authorized representatives of the contracting officer or of the University's Affirmative Action Office.
- v. Whenever the Supplier becomes contractually bound to the listing provisions of this clause, he shall advise the employment service system in each state wherein he has establishments of the name and location of each such establishment in the state. If the Supplier is contractually bound to these provisions and has so advised the state system, there is no need to advise the state system of subsequent contracts or purchase orders. The Supplier may advise the state system when it is no longer bound by this contract clause.
- vi. This clause does not apply to the listing of employment openings which occur and are filled outside of the 50 states, the District of Columbia, Puerto Rico, Guam, and the U.S. Virgin Islands.
- vii. This clause does not apply to openings which the Supplier proposed to fill from within his own organization or to fill pursuant to a customary and traditional employer-union hiring arrangement. This exclusion does not apply to a particular opening once an employer decides to consider applicants outside of his own organization or employer-union arrangement for that opening.
- viii. As used in this clause:
  1. "All suitable employment openings" includes, but is not limited to, openings which occur in the following job categories: production and nonproduction; plant and office; laborers and mechanics; supervisory and nonsupervisory; technical, executive administrative, and professional openings which are compensated on a salary basis of less than \$18,000 per year. This term includes full-time employment, temporary employment of more than three days' duration, and part-time employment. It does not include openings which the Supplier proposes to fill from within his own organization or to fill pursuant to a customary and traditional employer-union hiring arrangement. Under the most compelling circumstances an employment opening may not be suitable for listing, including the situations where the needs of the Government cannot reasonably be otherwise supplied, where listing would be contrary to national security, or where the requirement of listing would otherwise not be for the best interest of the Government.
  2. "Appropriate office of the state employment service system" means the local office of the federal-state national system or public employment offices with assigned responsibility for serving the area where the employment opening is to be filled, including the District of Columbia, Guam, Puerto Rico, and the U.S. Virgin Islands.
  3. "Openings which the Supplier proposes to fill from within his own organization" means employment openings for which no consideration will be given to persons outside the Supplier's organization (including any affiliates, subsidiaries, and the parent companies) and includes any openings which the Supplier proposes to fill from regularly established "recall" or "rehire" lists.
  4. "Openings which the Supplier proposes to fill pursuant to a customary and traditional employer-union hiring arrangement" means employment openings for which no consideration will be given to persons outside of a special hiring arrangement, including openings which the Supplier proposes to fill from union halls, which is part of the customary and traditional hiring relationship which exists between the Supplier and representatives of his employees.
  5. "Disable veteran" means a person entitled to disability compensation under the law administered by the Veterans' Administration for disability rates at 30 per centum or more, or a person whose discharge or release from active duty was for a disability incurred or aggravated in line of duty.
  6. "Veterans of the Vietnam era" means a person (1) who (i) served on active duty for a period of more than 180 days, any part of which occurred after August 5, 1964, and was discharged or released therefrom with other than a dishonorable discharge, or (ii) was discharged or released from active duty for service-connected disability if any part of such duty was performed after August 5, 1964, and (2) who was so discharged or released within the 48 months preceding his application for employment covered under this part.

*(Applicable to Supplier exceeding \$10,000 in Contracts with a University affiliated entity)*

This Contract is subject to the requirements of Executive Order 11701 and the regulations of the U.S. Secretary of Labor (41 CFR Chapter 60, Part 60-250) in promoting employment opportunities for disabled and Vietnam veterans.

During the performance of this contract or purchase order, Supplier agrees as follows:

- i. To provide special emphasis to the employment of qualified disabled veterans and veterans of the Vietnam era. The Supplier also agrees that all suitable employment openings of the Supplier which exist at the time of execution of this Contract and those which occur during the performance of this Contract, including those not generated by this Contract and including those occurring at an establishment of the Supplier other than the one wherein the Contract is being performed but excluding those of independently operated corporate affiliates, shall be offered for listing at an appropriate local office of the State Employment Service system wherein the opening occurs and to provide such reports to such local office regarding employment openings and hires as may be required: provided, that if the Contract or purchase order is for less than \$10,000 or if it is with a state or local government, the reports set forth in Paragraphs (iii) and (iv) of this clause are not required.
- ii. Listing of employment openings with the employment service system pursuant to this clause shall be made at least concurrently with the use of any other recruitment service or effort and shall involve the normal obligations which attach to the placing of a bona fide job order, including the acceptance of any particular job applicant or from any particular group of job applicants, and nothing herein is intended to relieve the Supplier from any requirements in Executive Order or regulations regarding nondiscrimination in employment.
- iii. The reports required by Paragraph (i) of this clause shall include, but not be limited to, periodic reports which shall be filed at least quarterly with the appropriate local office or where the Supplier has more than one establishment in a state, with the central office of the state employment service. Such reports shall indicate for each establishment (1) the number of individuals who were hired during the reporting period; (2) the number of those hired who were disabled veterans; and (3) the number who were nondisabled veterans of the Vietnam era.
- iv. The Supplier shall submit a report within thirty (30) days after the end of each reporting period wherein any performance is made on this contract or purchase order. The Supplier shall maintain copies of the reports submitted until the expiration of one year after final payment under the Contract, during which time they shall be made available, upon request, for examination by any authorized representatives of the contracting officer or of the University's Affirmative Action Office.
- v. Whenever the Supplier becomes contractually bound to the listing provisions of this clause, he shall advise the employment service system in each state wherein he has establishments of the name and location of each such establishment in the state. If the Supplier is contractually bound to these provisions and has so advised the state system, there is no need to advise the state system of subsequent contracts or purchase orders. The Supplier may advise the state system when it is no longer bound by this contract clause.
- vi. This clause does not apply to the listing of employment openings which occur and are filled outside of the 50 states, the District of Columbia, Puerto Rico, Guam, and the U.S. Virgin Islands.
- vii. This clause does not apply to openings which the Supplier proposed to fill from within his own organization or to fill pursuant to a customary and traditional employer-union hiring arrangement. This exclusion does not apply to a particular opening once an employer decides to consider applicants outside of his own organization or employer-union arrangement for that opening.
- viii. As used in this clause:
  1. "All suitable employment openings" includes, but is not limited to, openings which occur in the following job categories: production and nonproduction; plant and office; laborers and mechanics; supervisory and nonsupervisory; technical, executive administrative, and professional openings which are compensated on a salary basis of less than \$18,000 per year. This term includes full-time employment, temporary employment of more than three days' duration, and part-time employment. It does not include openings which the Supplier proposes to fill from within his own organization or to fill pursuant to a customary and traditional employer-union hiring arrangement. Under the most compelling circumstances an employment opening may not be suitable for listing, including the situations where the needs of the Government cannot reasonably be otherwise supplied, where listing would be contrary to national security, or where the requirement of listing would otherwise not be for the best interest of the Government.
  2. "Appropriate office of the state employment service system" means the local office of the federal-state national system or public employment offices with assigned responsibility for serving the area where the employment opening is to be filled, including the District of Columbia, Guam, Puerto Rico, and the U.S. Virgin Islands.
  3. "Openings which the Supplier proposes to fill from within his own organization" means employment openings for which no consideration will be given to persons outside the Supplier's organization (including any affiliates, subsidiaries, and the parent companies) and includes any openings which the Supplier proposes to fill from regularly established "recall" or "rehire" lists.
  4. "Openings which the Supplier proposes to fill pursuant to a customary and traditional employer-union hiring arrangement" means employment openings for which no consideration will be given to persons outside of a special hiring arrangement, including openings which the Supplier proposes to fill from union halls, which is



part of the customary and traditional hiring relationship which exists between the Supplier and representatives of his employees.

5. "Disable veteran" means a person entitled to disability compensation under the law administered by the Veterans' Administration for disability rates at 30 per centum or more, or a person whose discharge or release from active duty was for a disability incurred or aggravated in line of duty.
6. "Veterans of the Vietnam era" means a person (1) who (i) served on active duty for a period of more than 180 days, any part of which occurred after August 5, 1964, and was discharged or released therefrom with other than a dishonorable discharge, or (ii) was discharged or released from active duty for service-connected disability if any part of such duty was performed after August 5, 1964, and (2) who was so discharged or released within the 48 months preceding his application for employment covered under this part.

#### **6.4 Certificate of Nonsegregated Facilities**

*(Applicable to Suppliers exceeding \$10,000 in Contracts with a University affiliated entity)*

This Contract is subject to the requirements of Executive Order 11246 and the regulations of the U.S. Secretary of Labor (41 CFR Part 60-1.8) prohibiting segregated facilities based upon race, color, religion, sex, or national origin.

The undersigned Supplier certifies to the University and the Federal Government agencies with which it contracts that he does not maintain or provide for his employees any segregated facilities at any of his establishments, and that he does not permit the employees to perform their services at any location under his control where segregated facilities are maintained. The undersigned bidder, offeror, applicant, supplier, or subcontractor agrees that a breach of this certification is a violation of the Equal Opportunity Clause in this Contract. As used in this certification, the term "segregated facilities" means any waiting rooms, work areas, restrooms and washrooms, restaurants and other eating areas, time clocks, locker rooms and other storage or dressing areas, parking lots, drinking fountains, recreation or entertainment areas, transportation and housing facilities provided for employees which are segregated by explicit directive or are, in fact, segregated on the basis of race, creed, color, or national origin, because of habit, local custom, or otherwise. He further agrees that (except where he has obtained identical certifications from proposed subcontractors for specific time period) he will obtain identical certifications from proposed subcontractors prior to the award of subcontractors exceeding \$10,000 which are not exempt from the provisions of the Equal Opportunity Clause, that he will retain such certification in his files, and that he will forward the following notice to such proposed subcontractors (except where the proposed subcontractors have submitted identical certification for specific time periods):

#### **NOTICE TO PROSPECTIVE SUBCONTRACTORS OF REQUIREMENT FOR CERTIFICATION OF NONSEGREGATED FACILITIES**

A Certification of Nonsegregated Facilities must be submitted prior to the award of a subcontract exceeding \$10,000 which is not exempt from the provision of the Equal Opportunity Clause. The Certification may be submitted either for each subcontract or for all subcontracts or for all subcontracts during a period (i.e., quarterly, semiannually, or annually). NOTE: The penalty for making false statements in offers is prescribed in 18 U.S.C. 1001.

#### **6.5 Employment of Individuals with Disabilities**

*(Applicable to Suppliers exceeding \$10,000 in Contracts with a University affiliated entity)*

This Contract is subject to the requirements of Executive Order 11758, section 503 of the Rehabilitation Act of 1973, as amended, and the regulations of the U.S. Secretary of Labor (41 CFR Part 60-741.5) to promote the employment and advancement of qualified handicapped individuals.

During the performance of this Contract, Supplier agrees as follows:

- i. That it will not discriminate against any employee or applicant for employment because of physical or mental disability regarding any position for which the employee or applicant for employment is qualified. The contractor agrees to take affirmative action to employ, advance in employment, and otherwise treat qualified individuals with disabilities without discrimination based on their physical or mental disability in all employment practices including the following:
  1. Recruitment, advertising, and job application procedures.
  2. Hiring, upgrading, promotion, award of tenure, demotion, transfer, layoff, termination, right of return from layoff, and rehiring.
  3. Rates of pay or any other form of compensation and changes in compensation.
  4. Job assignments, job classifications, organizational structures, position descriptions, lines of progression, and seniority lists.
  5. Leaves of absence, sick leave, or any other leave.
  6. Fringe benefits available by virtue of employment, whether or not administered by the contractor.
- ii. That it will comply with the rules, regulations, and relevant orders of the Secretary of Labor issued pursuant to the act.
- iii. That in the event of noncompliance with the requirements of this clause, actions for noncompliance may be taken in accordance with the rules, regulations, and relevant orders of the Secretary of Labor issued pursuant to the act.
- iv. That it will post in conspicuous places, available to employees and applicants for employment, notices in a form to be prescribed by the Deputy Assistant Secretary for Federal Contract Compliance Programs, provided by or through the

contracting officer. Such notices shall state the rights of applicants and employees as well as the contractor's obligation under the law to take affirmative action to employ and advance in employment qualified employees and applicants with disabilities. The contractor must ensure that applicants and employees with disabilities are informed of the contents of the notice (e.g., the contractor may have the notice read to a visually disabled individual or may lower the posted notice so that it might be read by a person in a wheelchair).

- v. That it will notify each labor organization or representative of workers with which it has a collective bargaining agreement or other contract understanding that the contractor is bound by the terms of section 503 of the Rehabilitation Act of 1973, as amended, and is committed to take affirmative action to employ and advance in employment individuals with physical or mental disabilities.
- vi. That it will include the provisions of this clause in every subcontract or purchase order in excess of \$10,000, unless exempted by the rules, regulations, or orders of the Secretary issued pursuant to section 503 of the act, as amended, so that such provision will be binding upon each subcontractor or vendor. The contractor will take such action with respect to any subcontract or purchase order as the Deputy Assistant Secretary for Federal Contract Compliance Programs may direct to enforce such provisions, including action for noncompliance.

#### **6.6 Affirmative Action Program Requirement**

*(Applicable to Suppliers employing 50 or more employees and exceeding \$50,000 in Contracts with a University affiliated entity)*

This Contract is subject to the requirements of Executive Order 11758, section 503 of the Rehabilitation Act of 1973, as amended, and the regulations of the U.S. Secretary of Labor (41 CFR Part 60-741.40) in promoting affirmative action in Employment of the Handicapped. Supplier agrees to conform to its requirements as outlined in 41 CFR Part 60-741.44.

Furthermore, Supplier agrees to develop a written Affirmative Action Compliance Program for each of its establishments as required by 41 CFR 60-2.1.

#### **6.7 Filing Certificate**

*(Applicable to Suppliers employing 50 or more employees and exceeding \$50,000 in Contracts with a University affiliated entity)*

Supplier has filed or will file the necessary compliance reports, including Standard Form 100 (EEO-1) where and when required by law and applicable regulations, including, without limitation, the Civil Rights Act of 1964 as amended by the Equal Employment Opportunity Act of 1972 and regulations in 41 CFR 60-1.7. Supplier further agrees that it shall require similar certification and filing from its nonexempt subcontractors and suppliers. The Supplier agrees to submit a copy of his Affirmative Action Program to the Affirmative Action Office, University of Louisville, within 30 days after the award to him of a Contract. Subsequent reports shall be submitted annually in accordance with 41 CFR 60-1.7(a)(1).

#### **6.8 Affirmative Action Certificate**

*(Applicable to Suppliers employing 50 or more employees and exceeding \$50,000 in Contracts with a University affiliated entity)*

Supplier has developed, is maintaining, and will continue to maintain the written affirmative action compliance program to guarantee equal employment opportunity to minority groups required by applicable laws and regulations, including, without limitations, those appearing in 41 CFR 60-1.40. Supplier further agrees that it shall require similar certification and filing from its nonexempt subcontracts and suppliers.<sup>1</sup>

#### **6.9 Administrative, Contractual, Legal Remedies**

*(Applicable to federally funded Contracts exceeding \$150,000 [or a higher threshold if the \$150,000 is adjusted for inflation as determined by the Civilian Agency Acquisition Council and the Defense Acquisition Regulations Council])*

Supplier acknowledges that the applicable University affiliated entity may impose sanctions or penalties on the Supplier for violation of terms of the Contract or breach of contract including violation of applicable regulations, other applicable provisions of law, or any directive or instruction from the University affiliated entity or federal entity providing the funding. The University affiliated entity will determine the appropriate sanction and/or penalty, up to and including the inability to provide future goods or services to any University affiliated entity. In determining the appropriate sanction and/or penalty, the University affiliated entity will consider previous violations, potential harm to the project for which the goods or services are being provided, and any other relevant factors. The Supplier will be notified in writing of the intent to sanction and/or penalize and will have ten (10) business days from the date of receipt of the notice to submit a written response. The response will be reviewed, and a final decision will be communicated in writing to the Supplier. These sanctions or penalties do not preclude the University affiliated entity, nor the Supplier, from pursuing any other alternate dispute resolution or legal remedy to which either may be entitled under law or regulation.

#### **6.10 Davis Bacon Act**

---

<sup>1</sup> Non-construction contractors should refer to 41 CFR Part 60-2 for specific affirmative action requirements. Construction contractors should refer to 41 CFR Part 60-4 for specific affirmative action requirements.

*(Applicable to federally funded construction projects exceeding \$2,000)*

Supplier agrees to pay wages to mechanics and laborers at a rate not less than the prevailing wages specified in a wage determination made by the Secretary of Labor. Supplier agrees to pay wages and meet the other requirements as specified by Davis-Bacon Act, as amended (40 U.S.C. 3141-3148) as supplemented by the Department of Labor regulations (29 CFR Part 5). Supplier acknowledges that the University affiliated entity's decision to make a Contract with Supplier is conditioned upon the acceptance of the wage determination.

**6.11 Contract Work Hours and Safety Standards Act**

*(Applicable to federal funded Contracts exceeding \$100,000 which involves the employment of mechanics and laborers)*

Supplier agrees to pay salaries and wages in accordance with the Contract Work Hours and Safety Standards Act (40 U.S.C. 3701-3708) as supplemented by Department of Labor regulations (29 CFR part 5). Supplier acknowledges that such requirements include computation of wages of a standard work week of 40 hours for every mechanic and laborer and that work more than the standard work week is permissible provided the worker is compensated at a rate no less than one and a half times the basic rate of pay for all hours worked in excess of 40 hours in the work week. These requirements do not apply to purchases of supplies or materials or articles ordinarily available on the open market, or contracts for transportation or transmission of intelligence.

**6.12 Clean Air and Federal Water Pollution Control Act**

*(Applicable to federally funded Contracts exceeding \$150,000)*

Supplier agrees to comply with all applicable standards, orders, or regulations issued pursuant to the Clean Air Act (42 U.S.C. 7401-7671q) and the Federal Water Pollution Control Act as amended (33 U.S.C. 1251-1387). Supplier acknowledges the requirement to report any violations with the funding Federal agency and to the Regional Office of the Environmental Protection Agency (EPA) and agrees to notify the University affiliated entity of any such violations.

**6.13 Termination**

*(Applicable to federally funded Contracts exceeding \$10,000)*

The University affiliated entity shall have the right to terminate/cancel this Contract at any time upon thirty (30) days' written notice to the Supplier. The University affiliated entity shall pay Supplier for termination costs as allowable under OMB Circular a-21 or 2 CFR Part 200 as applicable.

**6.14 Lobbying/Anti-Kick Back**

Copeland Anti-Kick Back Act:

*(Applicable to any federally funded Contracts or funded by a federal loan)*

The Supplier agrees to comply with the Copeland "Anti-Kick Back" Act (18 U.S.C. 874) as supplemented in the Department of Labor Regulations (29 CFR, Part 3). This Act provides that each Supplier, Bidder, subcontractor or subgrantee is prohibited from inducing, by any means, any person employed in the construction, prosecution, completions, or repair of any public building, public work, or building or work financed in whole or in part by loans or grants from the United States to give up any part of the compensation to which he is otherwise entitled.

**Certification Governing Lobbying:**

*(Applicable to federally funded Contracts exceeding \$100,000)*

The Supplier certifies to the best of his/her knowledge and belief that:

- i. No Federal appropriated funds have been paid or will be paid, by or on behalf of the Supplier, to any person for influencing or attempting to influence an officer or employee of any agency, a Member of Congress, an officer or employee of Congress, or an employee of a Member of Congress in connection with the awarding of any Federal contract, the making of any Federal grant, the making of any Federal loan, the entering into of any cooperative agreement, and the extension, continuation, renewal, amendment, or modification of any Federal contract, grant, loan, or cooperative agreement.
- ii. If any funds other than Federally appropriated funds have been paid or will be paid to any person for influencing or intending to influence an officer or employee of any agency, a Member of Congress, an officer or employee of Congress, or an employee of a Member of Congress in connection with this Federal contract, grant, loan, or cooperative agreement, the Supplier shall complete and submit Standard Form -LLL, "Disclosure Form to Report Lobbying", to the University affiliated entity.

- iii. The Supplier shall require that the language of this certification be included in the award documents for all subawards at all tiers (including subcontracts, subgrants, and contracts under grants, loans, and cooperative agreements) and that all subrecipients shall certify and disclose accordingly.

This certification is a material representation of fact upon which reliance was placed when this transaction was made or entered into. Submission of this certification is a prerequisite for making or entering into this transaction imposed by Section 1352, Title 31, U.S. Code. Any person who fails to file the required certification shall be subject to a civil penalty of not less than \$10,000 and not more than \$100,000 for each such failure.

**6.15 Access to Records**

*(Applicable to any federally funded Contracts)*

The University affiliated entity reserves the right to inspect, upon reasonable advance notice by the University affiliated entity and during normal business hours, Supplier's physical facilities, and all books, records, and documents of any kind pertaining to this Contract or Supplier's performance of supplying the goods or services provided by the Contract. Supplier agrees to provide copies of any records, receipts, accounts, or other documentation to the University affiliated entity in a timely fashion as reasonably requested by the University affiliated entity. Supplier will keep all usual and proper records and books of accounts in accordance with Generally Accepted Accounting Principles (GAAP) relating to the performance of the Contract for a minimum period of three (3) years after the date of receipt of the final payment.

**6.16 Audits**

*(Applicable to any federally funded Contracts)*

Supplier assures University affiliated entity that it complies with either A-133 or the applicable provisions of 2 CFR Part F Audit Requirements (§200.500-200.520) applicable to assurances from subawards/subcontracts and that it will notify the University affiliated entity of completion of required audits and of any adverse findings which impact this Agreement, including those required audits conducted in accordance with the Generally Accepted Government Auditing Standards (GAGAS). The University affiliated entity reserves the right to inspect, upon reasonable advance notice and during normal business hours, Supplier's physical facilities used to provide the Services undertaken under this Agreement, and all books, records, and documents of any kind pertaining to the provision of the Services provided under this Agreement. Supplier agrees to provide copies of any records, receipts, accounts, or other documentation in a timely fashion as reasonably requested by the University affiliated entity. Supplier will keep all usual and proper records and books of accounts in accordance with GAAP relating to performance/provision of Services for a minimum period of three (3) years after the date of receipt of the final payment.

**6.17 Rights to Inventions Made Under a Contract or Agreement**

If the Federal award meets the definition of "funding agreement" under 37 CFR §401.2 (a) and the recipient or subrecipient wishes to enter into a contract with a small business firm or nonprofit organization regarding the substitution of parties, assignment or performance of experimental, developmental, or research work under that "funding agreement", the recipient or subrecipient must comply with the requirements of 37 CFR Part 401, "Rights to Inventions Made by Nonprofit Organizations and Small Business Firms Under Government Grants, Contracts and Cooperative Agreements", and any implementing regulations issued by the awarding agency.

**6.18 Debarment and Suspension (Executive Orders 12549 and 12689)**

Non-Federal entities are subject to the non-procurement debarment and suspension regulations implementing Executive Orders 12549 and 12689, [2 CFR part 180](#). The regulations in 2 CFR part 180 restrict awards, subaward, and contracts with certain parties that are debarred, suspended, or otherwise excluded from or ineligible for participation in Federal assistance programs or activities.

**6.19 Prohibition on Certain Telecommunications and Video Surveillance Services or Equipment**

Recipients and subrecipients are prohibited from obligating or expending loan or grant funds to:

- 6.19.1.1** Procure or obtain;
- 6.19.1.2** Extend or renew a contract to procure or obtain; or
- 6.19.1.3** Enter into a contract (or extend or renew a contract) to procure or obtain equipment, services, or systems that used covered telecommunications equipment or services as a substantial or essential component of any system, or a critical technology as part of any system. As described in Public Law 115-232, section 889, covered telecommunications equipment is telecommunications equipment produced by Huawei Technologies Company or ZTE Corporation (or any subsidiary or affiliate of such entities).
  - i. For the purposes of public safety, security of government facilities, physical security surveillance of critical infrastructure, and other national security purposes, video surveillance and telecommunications equipment produced by Hytera Communications Corporation, Hangzhou Hikvision Digital Technology Company, or Dahua Technology Company (or any subsidiary of such entities).

- ii. Telecommunications or video surveillance services provided by such entities or using such equipment.
- iii. Telecommunications or video surveillance equipment or services produced or provided by an entity that the Secretary of Defense, in consultation with the Director of National Intelligence or the Director of National Intelligence or the Director of the Federal Bureau of Investigation, reasonable believes to be an entity owned or controlled by, or otherwise connected to, the government of a covered foreign country.

**6.19.1.4** In implementing the prohibition under Public Law 115-232, section 889, subsection (f), paragraph (1), head of executive agencies administering loan, grant, or subsidy programs shall prioritize available funding and technical support to assist affected business, institutions, and organizations as is reasonably necessary for those affected entities to transition from covered communications equipment and services, to procure replacement equipment and services, and ensure that communications services to users and customers is sustained.

**6.19.1.5** See Public Law 115-232, section 889 for additional information.

**6.19.1.6** See also §200.471.

## **6.20 Domestic Preferences for Procurements**

As appropriate and to the extent consistent with law, the non-Federal entity should, to the greatest extent practicable under a Federal award, provide a preference for the purchase, acquisition, or use of goods, products, or materials produced in the United States (including but not limited to iron, aluminum, steel, cement, and other manufactured products). The requirements of this section must be included in all subawards including all contracts and purchase orders for work or products under this award.

For purposes of this section:

**6.20.1.1** “Produced in the United States” means for iron and steel products, that all manufacturing processes, from the initial melting stage through the application of coatings, occurred in the United States.

**6.20.1.2** “Manufactured products” means items and construction materials composed in whole or in part of non-ferrous metals such as aluminum; plastics and polymer-based products such as polyvinyl chloride pipe; aggregates such as concrete; glass, including optical fiber; and lumber.

## **6.21 Never Contract with the Enemy**

Federal awarding agencies and recipients are subject to the regulations implementing Never Contract with the Enemy in 2 CFR part 183. The regulations in 2 CFR part 183 affect covered contracts, grants, and cooperative agreements that are expected to exceed \$50,000 within the period of performance, are performed outside the United States and its territories, and are in support of a contingency operation in which members of the Armed Forces are actively engaged in hostilities.

---

*This Supplier Certification is hereby incorporated into the applicable Contract with you. Your signature on the Contract, acceptance of the contract/purchase order, acceptance of payment, or other form of acceptance/acknowledgement (e.g., continuing business relationship) with a University affiliated entity indicates your agreement to and acceptance of the applicable provisions. No counteroffer or provision of alternate terms and conditions is accepted by the University affiliated entity. Any changes must be agreed to in a signed separate writing specifically addressing the particular provision(s).*

# ATTACHMENT A: Design Package

## DESIGN SCOPE

# PROJECT SCOPE // LEVEL 1

- 1** SOUTH ENTRY
- 2** MAIN CORRIDOR
- 3** ROTUNDA
- 4** WOMEN'S TEAM LOUNGE
- 5** WOMEN'S LOCKER ROOM
- 6** TEAM DINING ROOM
- 7** RECRUITING LOUNGE
- 8** TRAINING ROOM
- 9** CLASSROOM
- 10** MEN'S TEAM LOUNGE



LEVEL 1

# **DESIGN CONCEPTS**



# SOUTH ENTRY



Paint black (by UL)

Dimensional lettering

Dimensional lettering

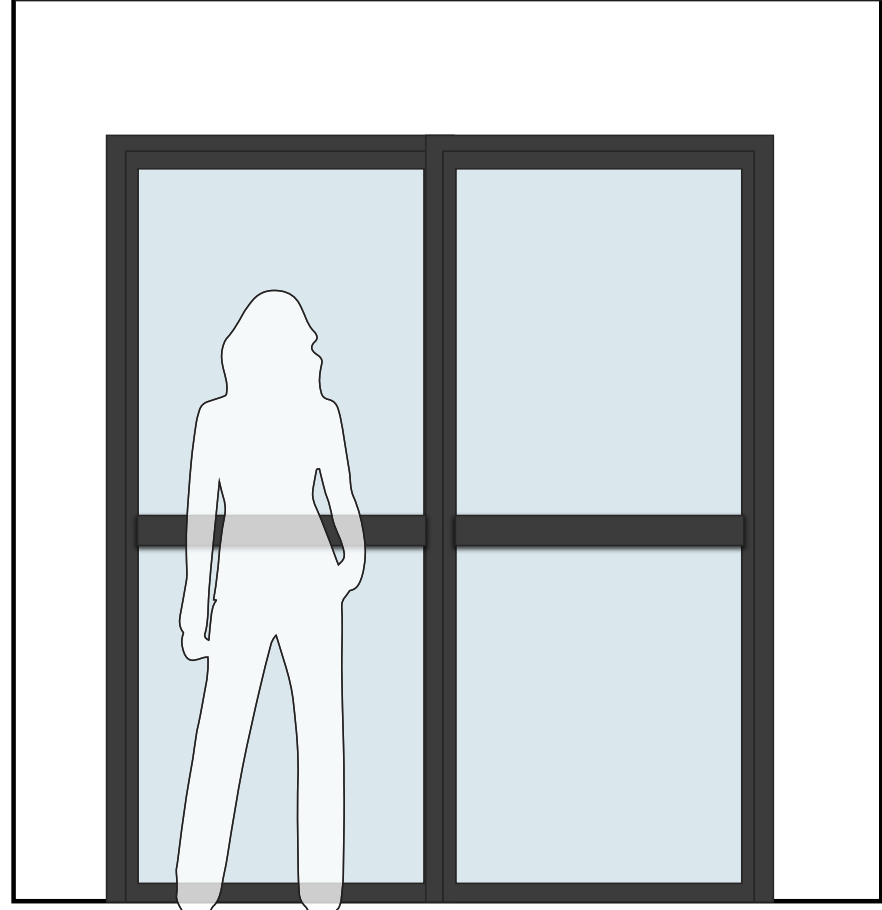

ELEVATION

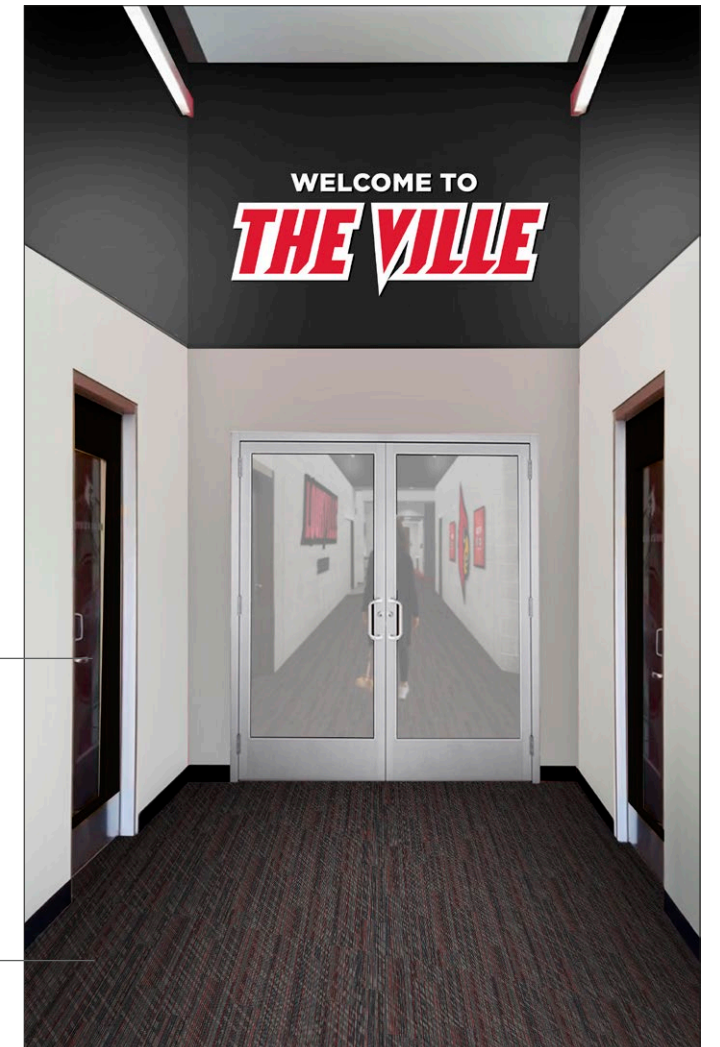

Paint doors black (by UL)

New carpet (by UL)

RENDERING



LOCATION // LEVEL 1

# SOUTH ENTRY

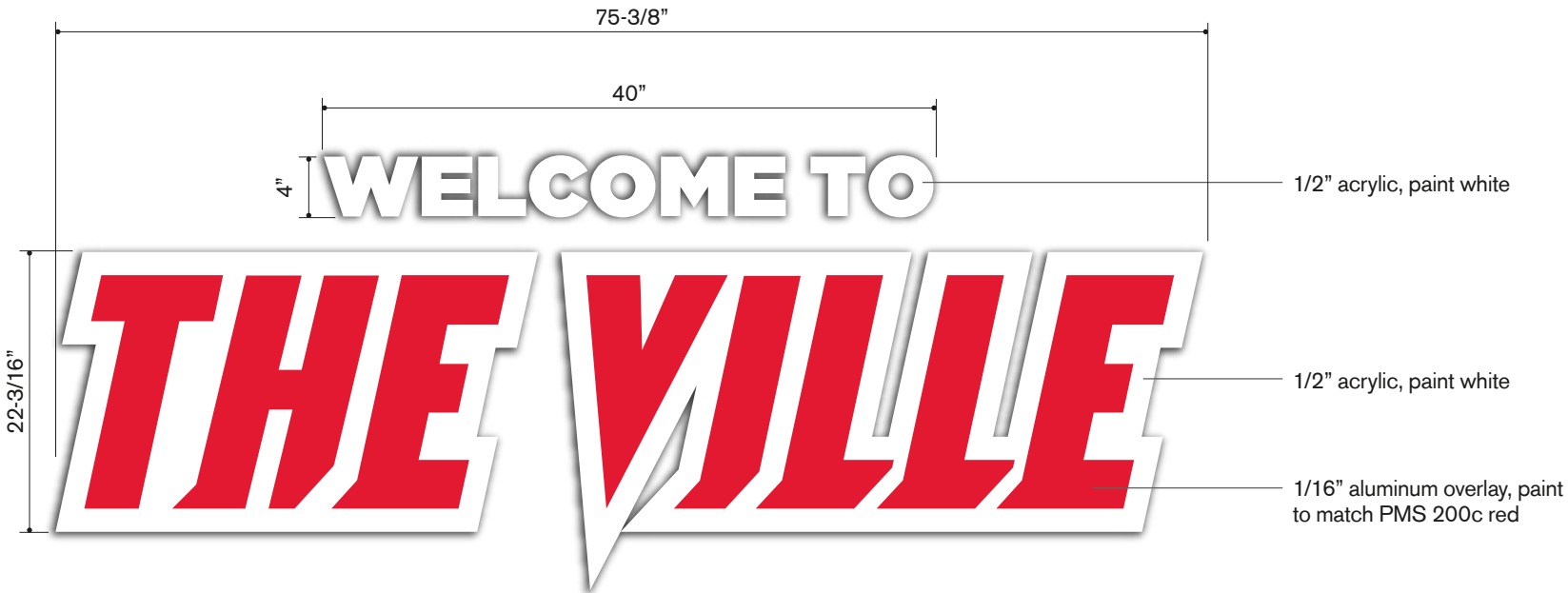

DIMENSIONAL LETTERING/LOGO



RENDERING



LOCATION // LEVEL 1

# MAIN CORRIDOR

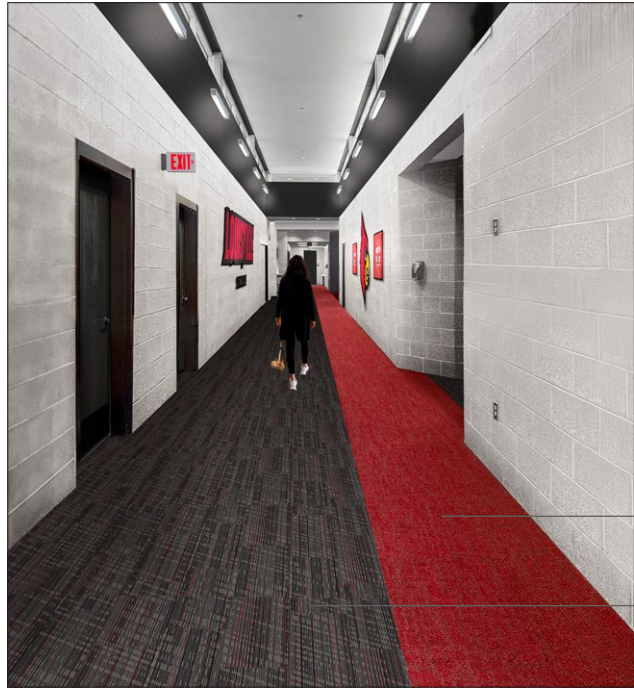
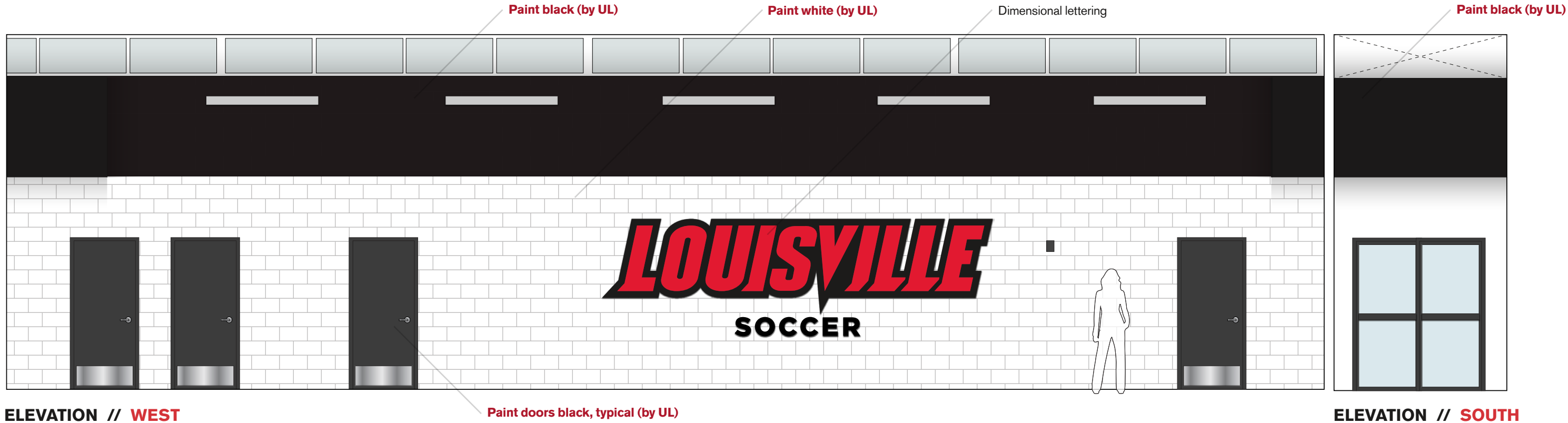

RENDERING

New carpet (by UL)

New carpet (by UL)



LOCATION // LEVEL 1

# MAIN CORRIDOR



## DIMENSIONAL LETTERING/LOGO



## RENDERING

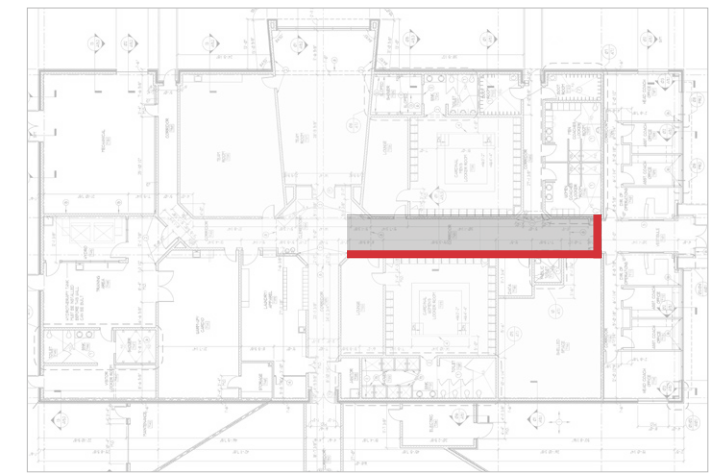

## LOCATION // LEVEL 1

# MAIN CORRIDOR

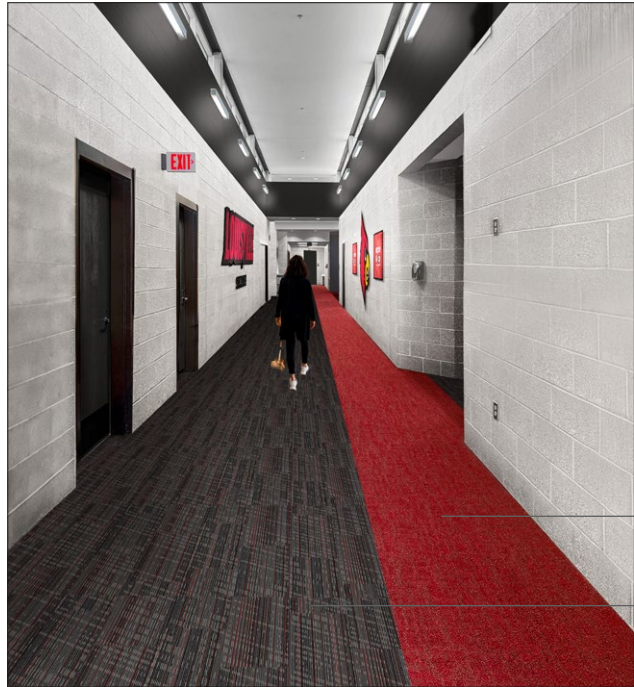
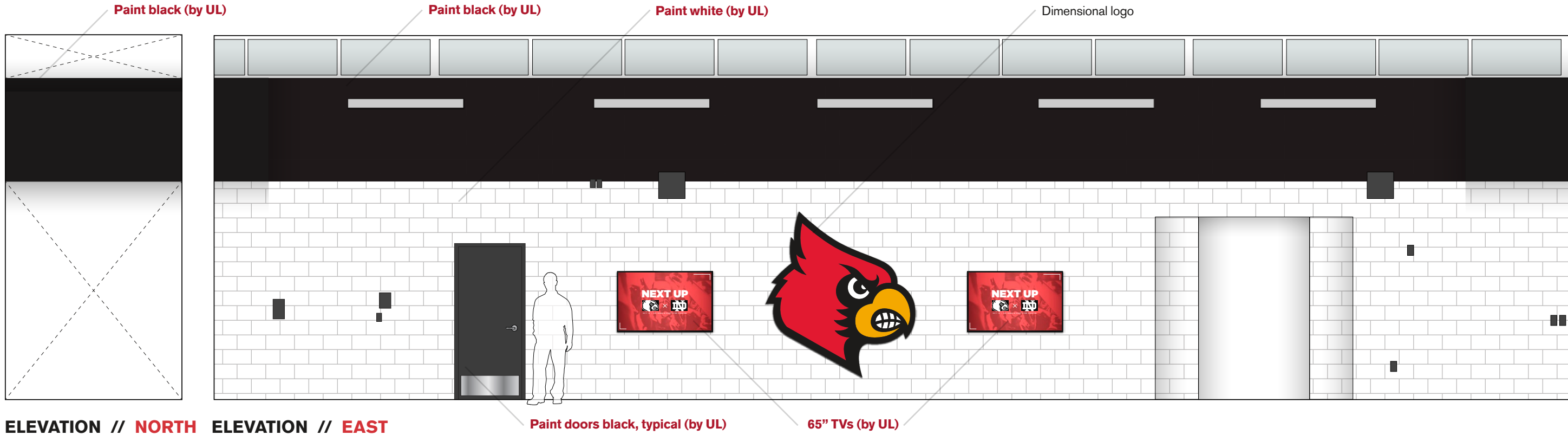

RENDERING

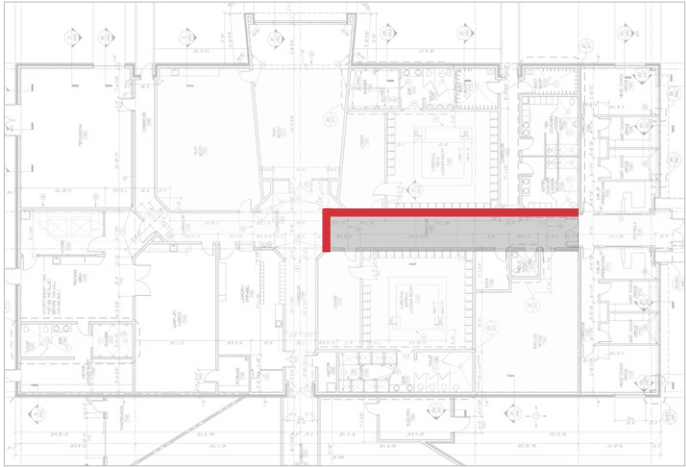

LOCATION // LEVEL 1

# MAIN CORRIDOR

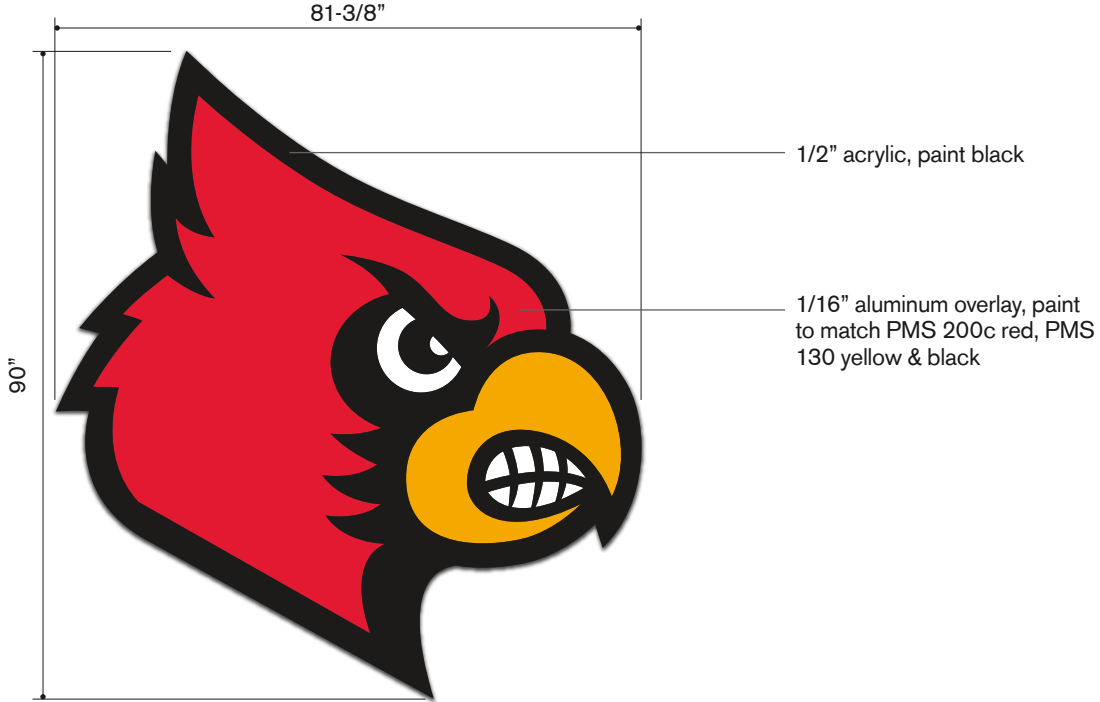

**DIMENSIONAL LOGO**

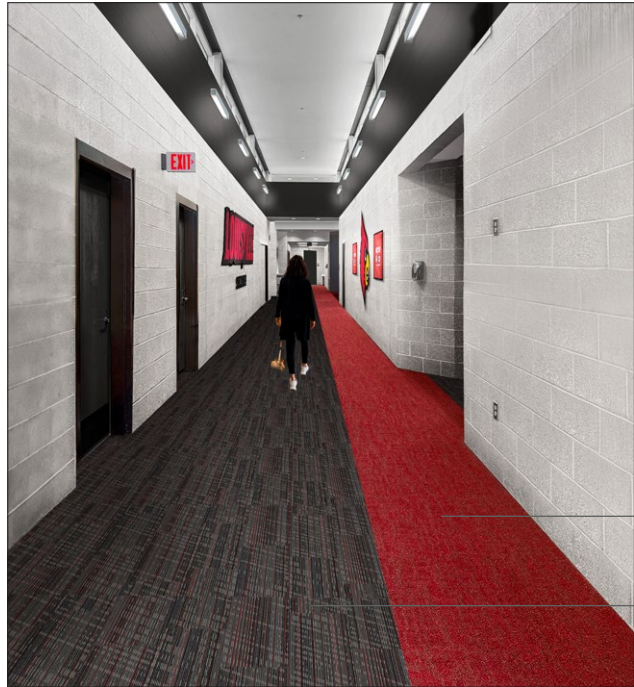

**RENDERING**

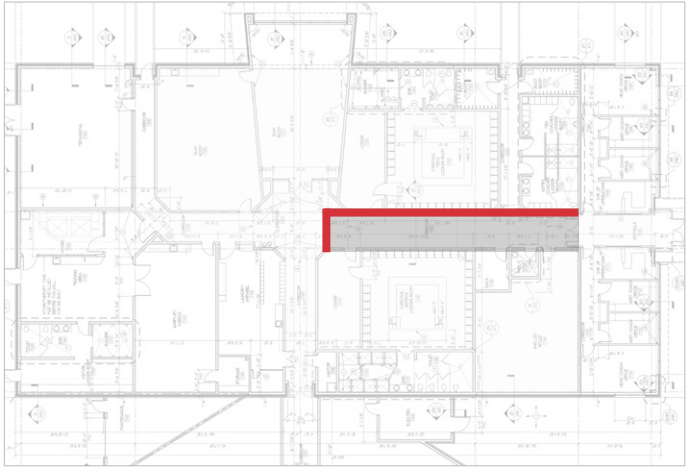

**LOCATION // LEVEL 1**

# ROTUNDA



- Paint black (by UL)
- Ceiling-mounted dimensional logo (UL to relocate sprinkler)
- Translucent red vinyl
- Dimensional logo
- Paint black (by UL)
- Paint white (by UL)
- Acrylic accent (Q:4)
- Trophy display (Q:2)
- Frosted vinyl
- New carpet (by UL)



**EXISTING**

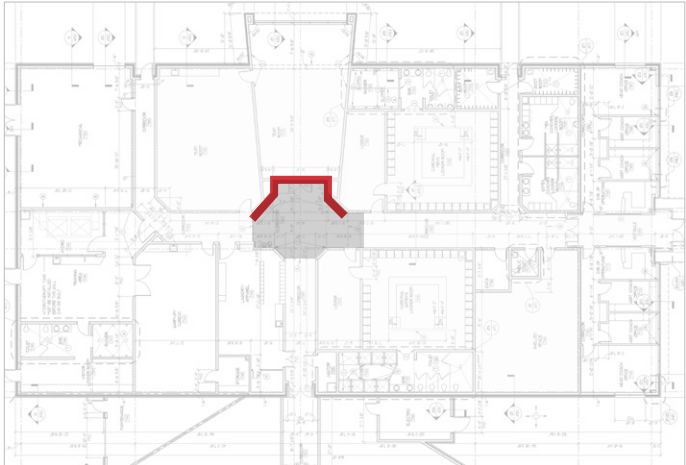

**LOCATION // LEVEL 1**

**RENDERING**

# ROTUNDA



**DIMENSIONAL CEILING LOGO**

4" deep aluminum can, paint to match PMS 200c red, PMS 130 yellow & black with white perimeter and returns

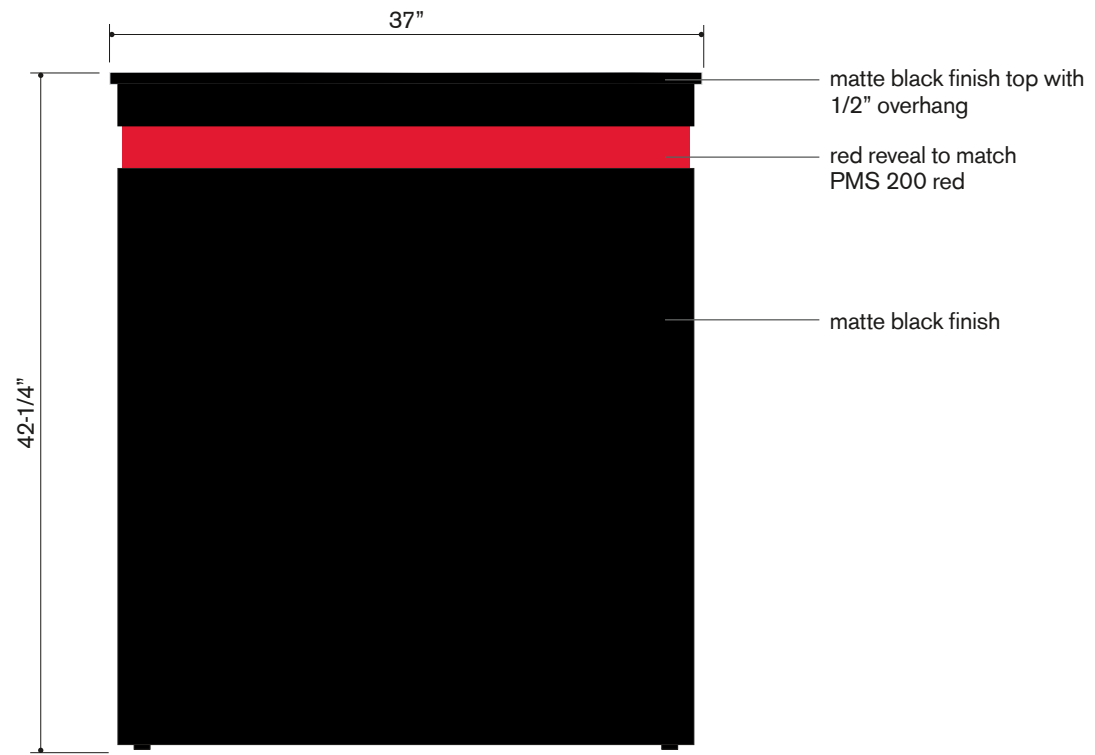

**TROPHY PEDESTAL // FACE VIEW**  
QTY = 2

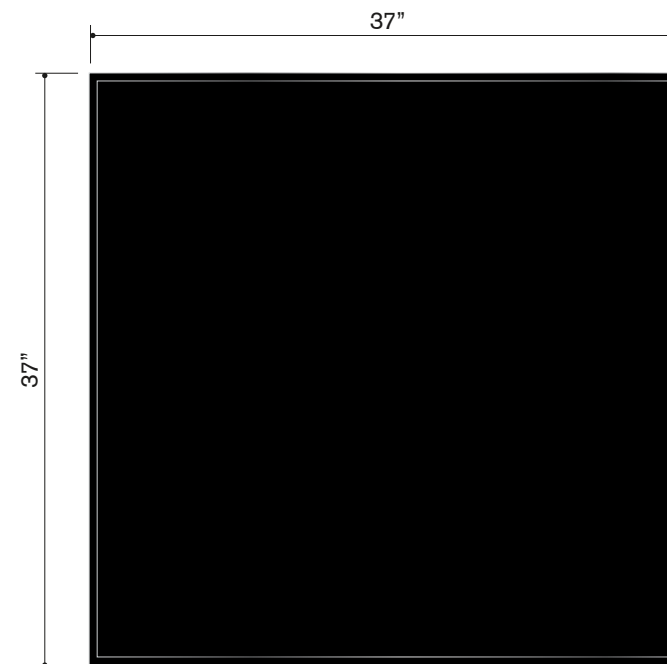

**TROPHY PEDESTAL // TOP VIEW**



**EXISTING**

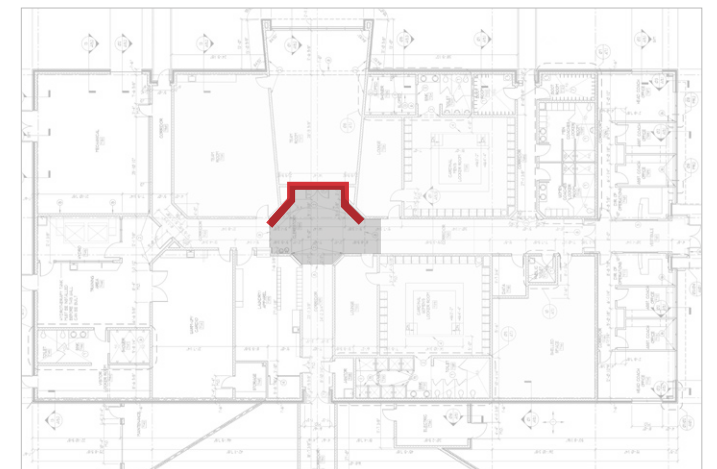

**LOCATION // LEVEL 1**



# ROTUNDA

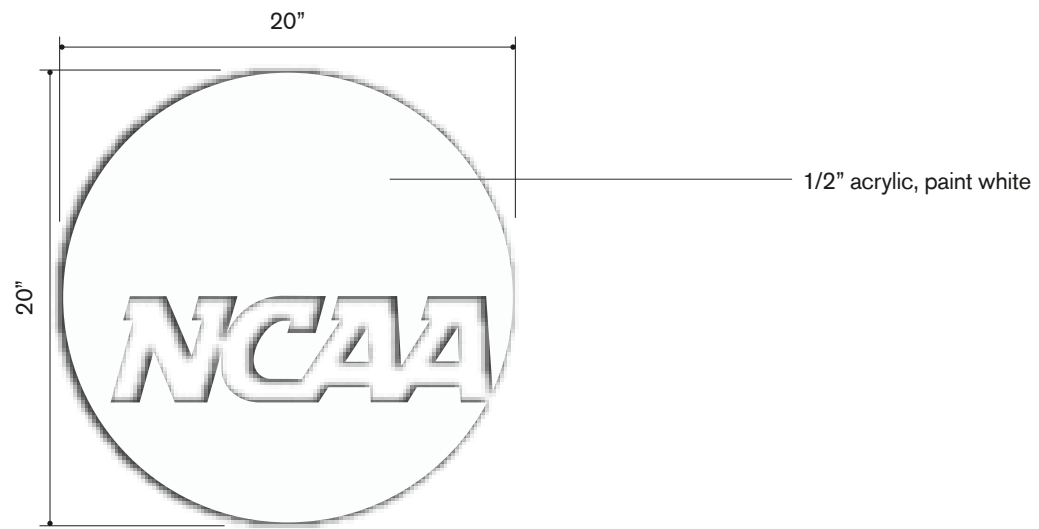
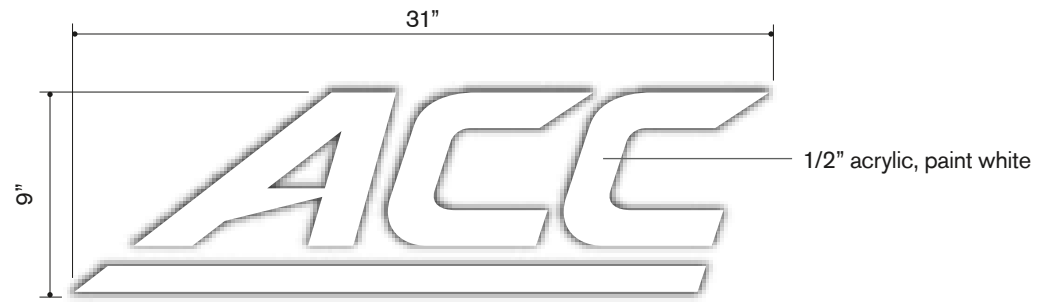

**DIMENSIONAL LOGOS**

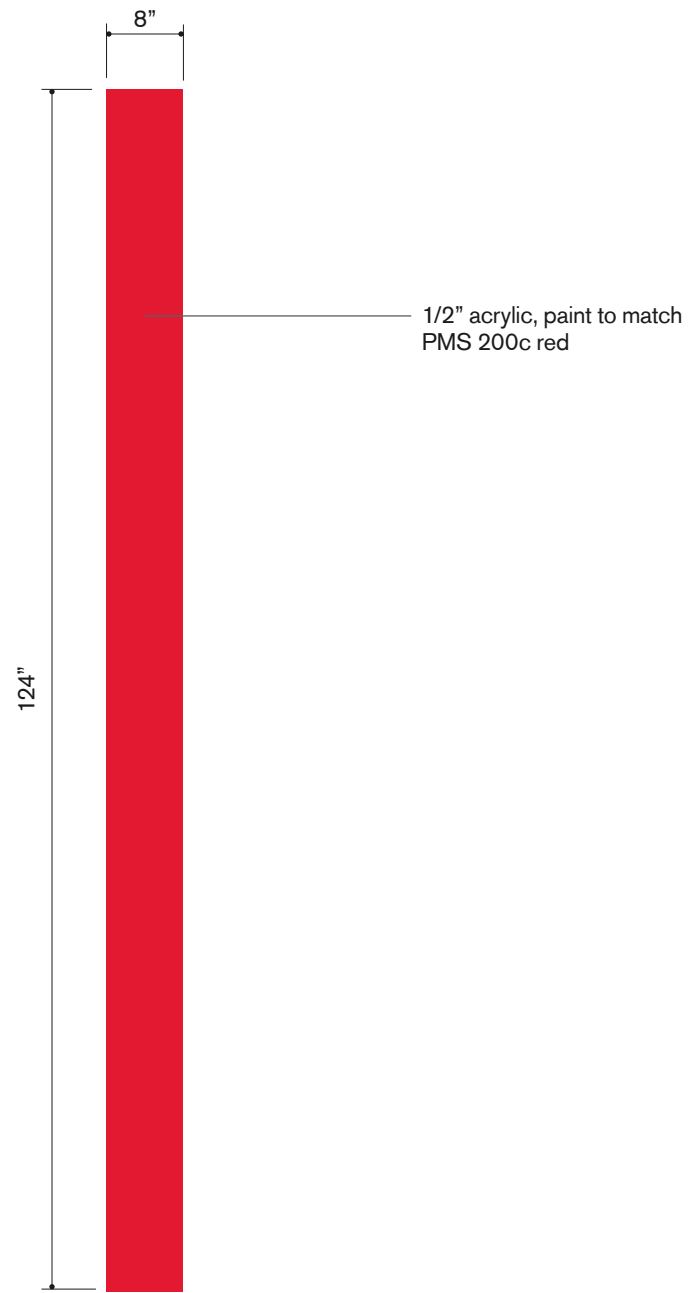

**DIMENSIONAL ACCENTS**  
QTY = 4



**EXISTING**

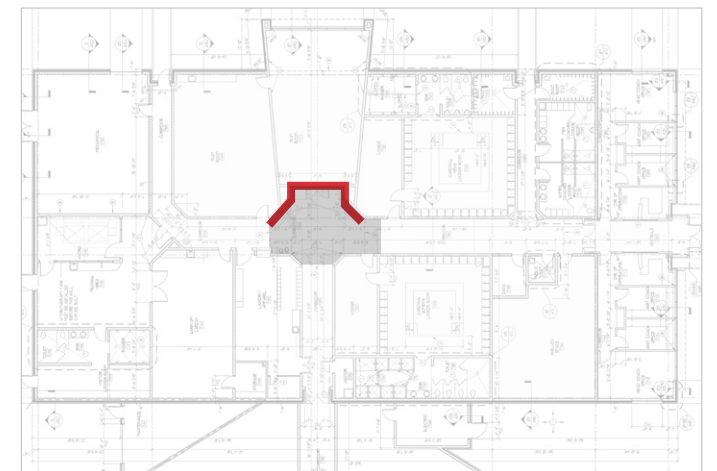

**LOCATION // LEVEL 1**

# RECRUITING LOUNGE ENTRY

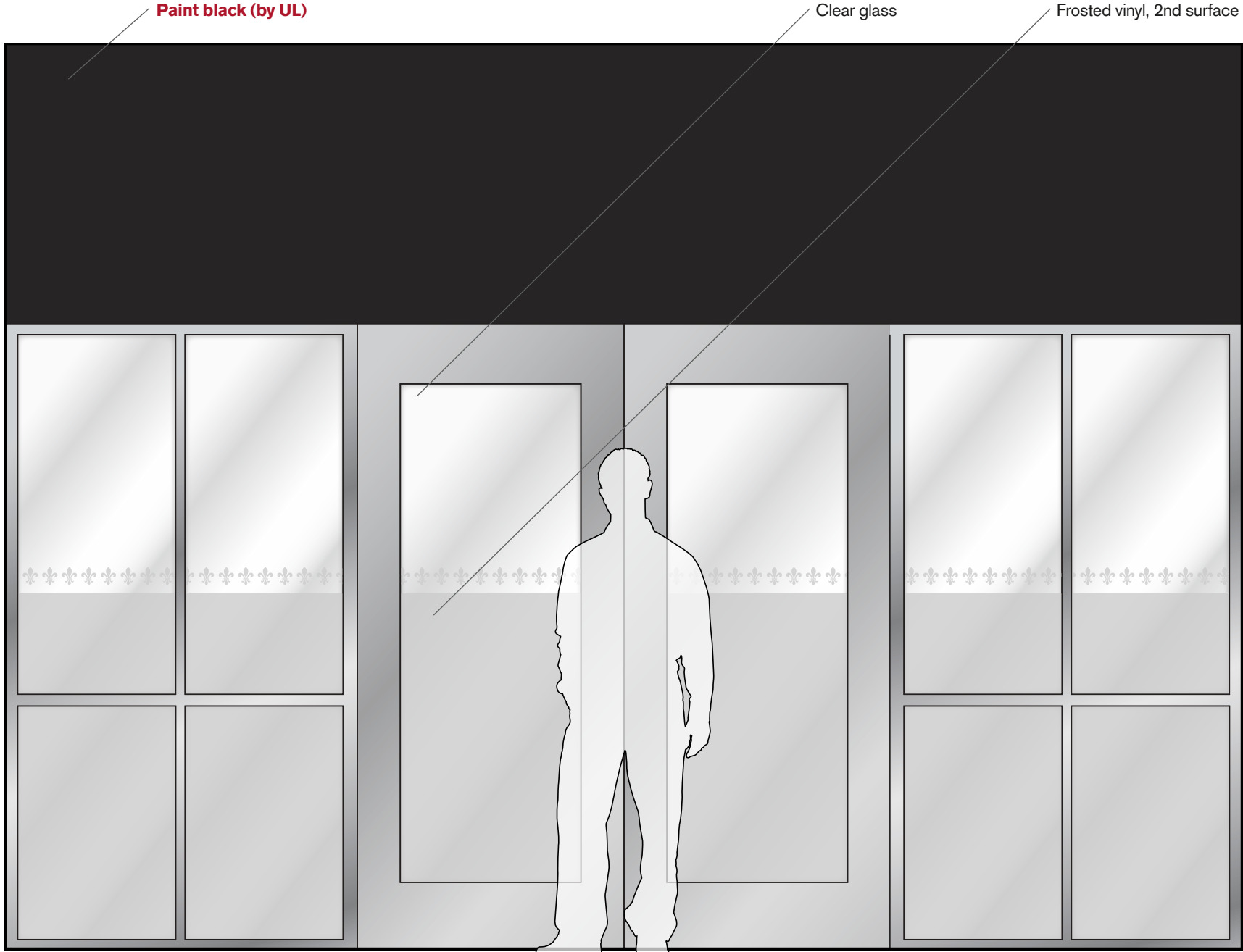

ELEVATION // EAST



RENDERING

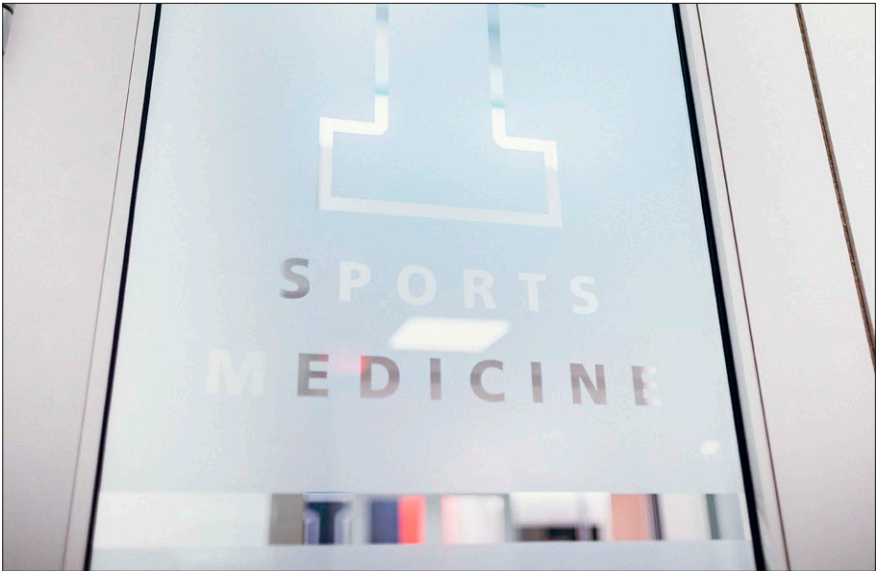

REFERENCE // FROSTED VINYL

# RECRUITING LOUNGE ENTRY

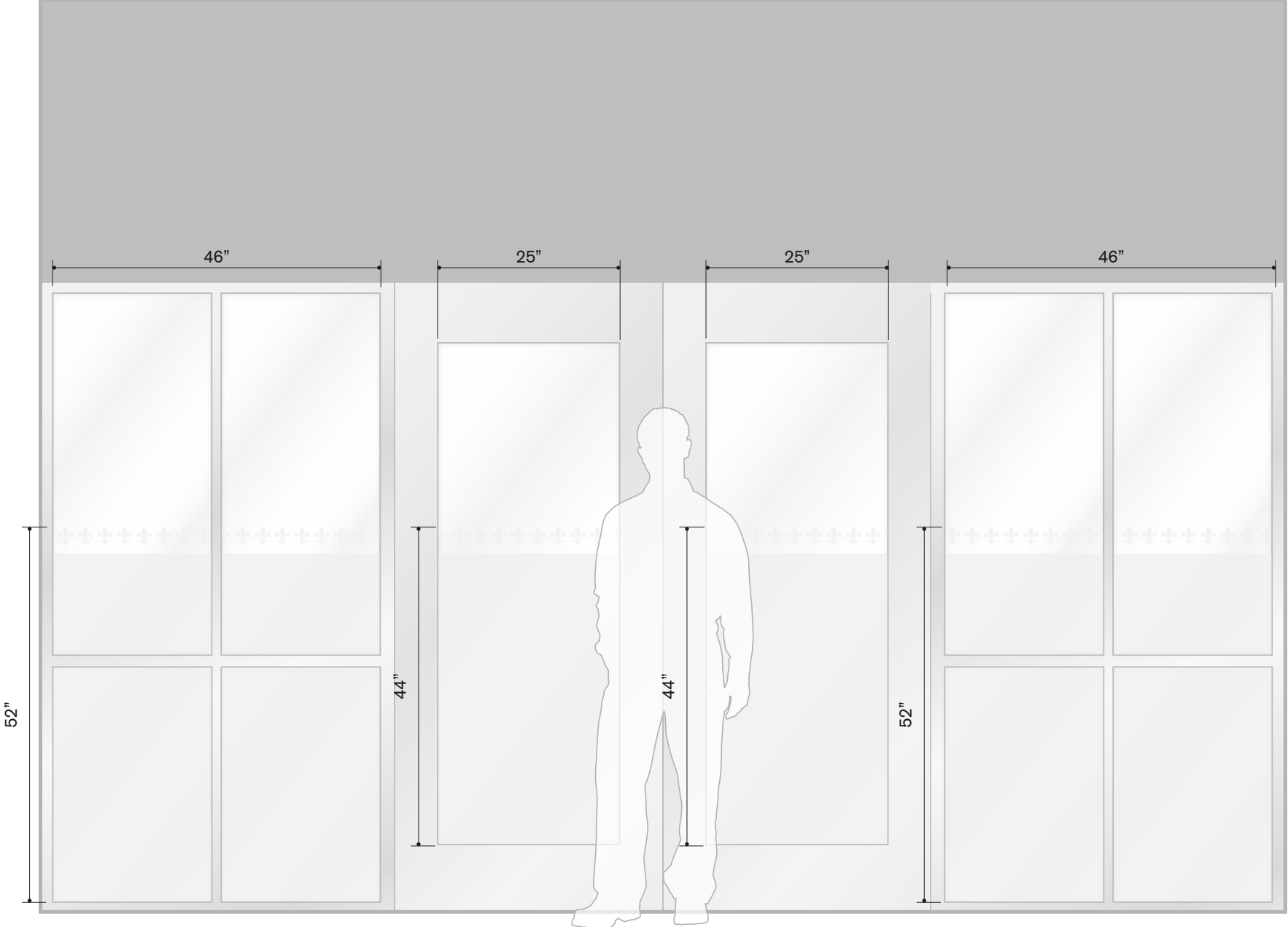

ETCH MARK CONTOUR CUT VINYL



RENDERING

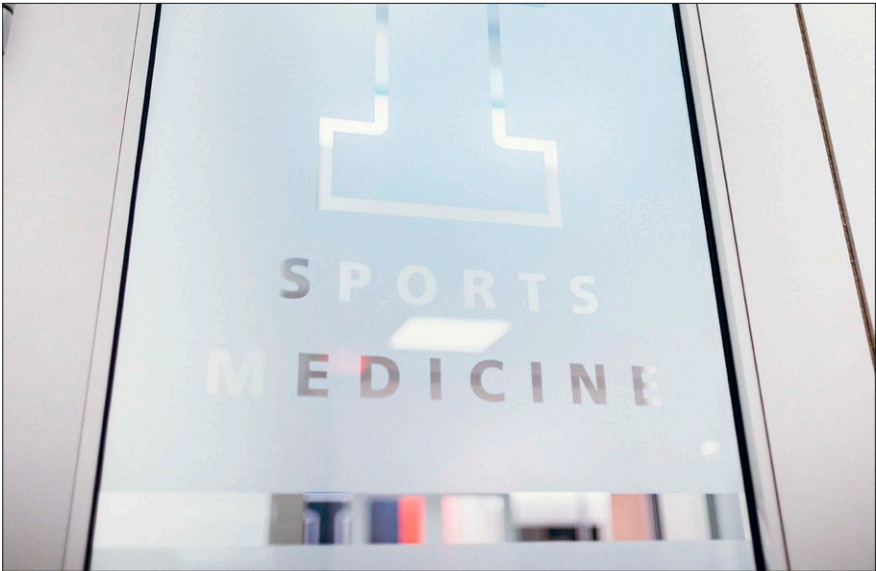

REFERENCE // FROSTED VINYL

# WOMEN'S TEAM LOUNGE // **RENDERING**



Paint black (by UL)

# WOMEN'S TEAM LOUNGE

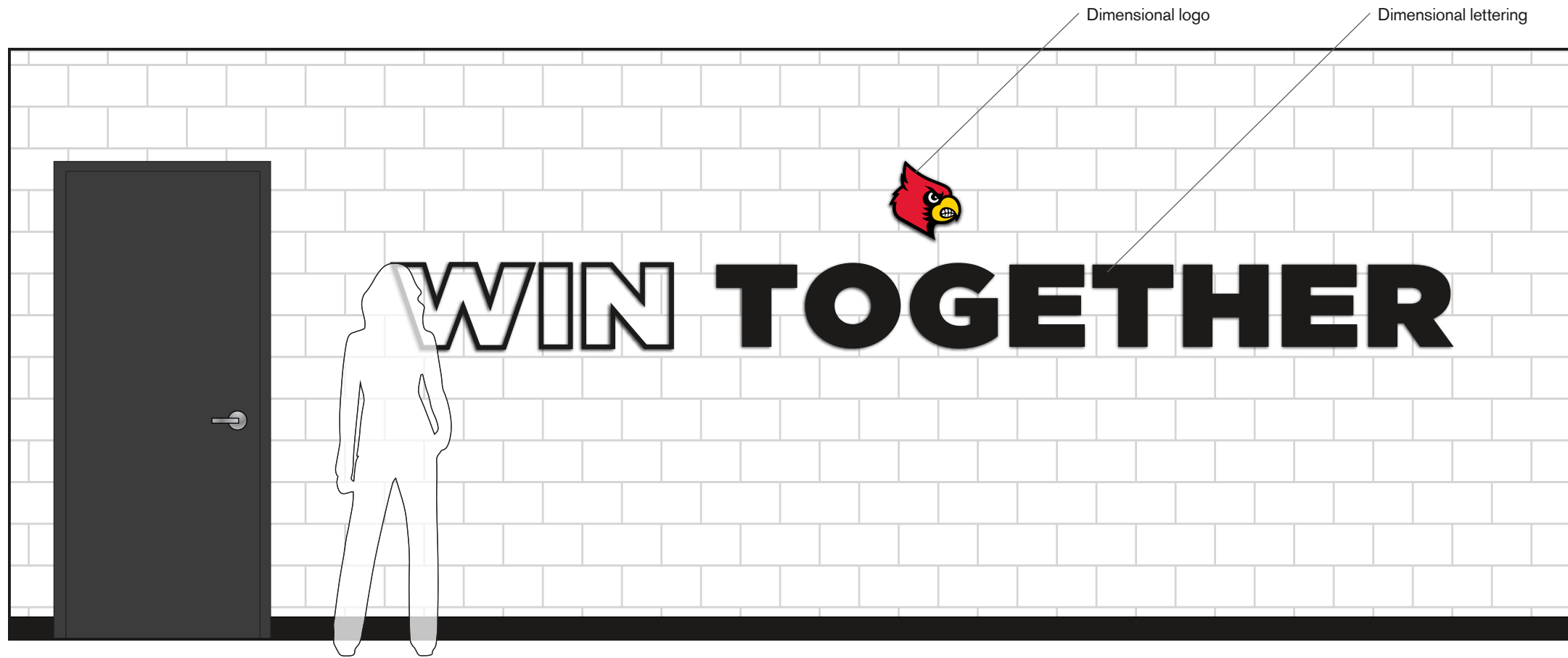

ELEVATION // NORTH

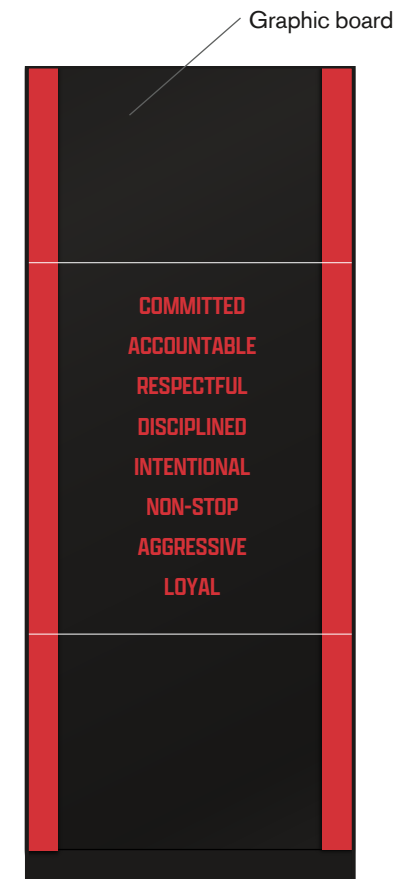

ELE. // NORTHEAST

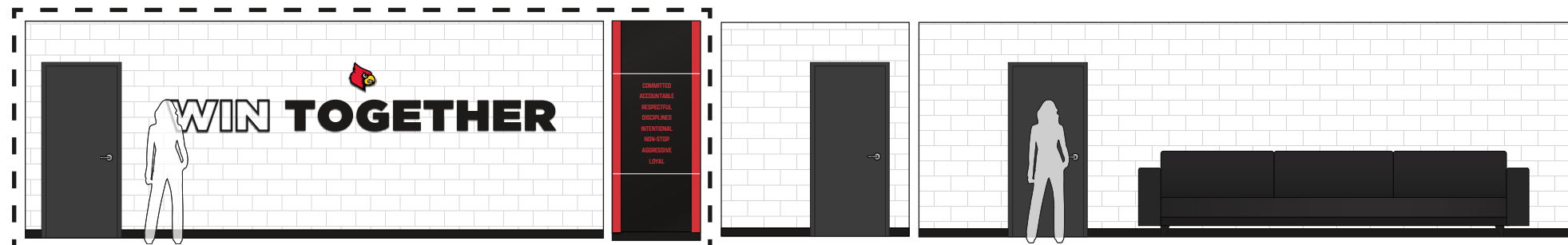

PANORAMIC



LOCATION // LEVEL 1

# WOMEN'S TEAM LOUNGE

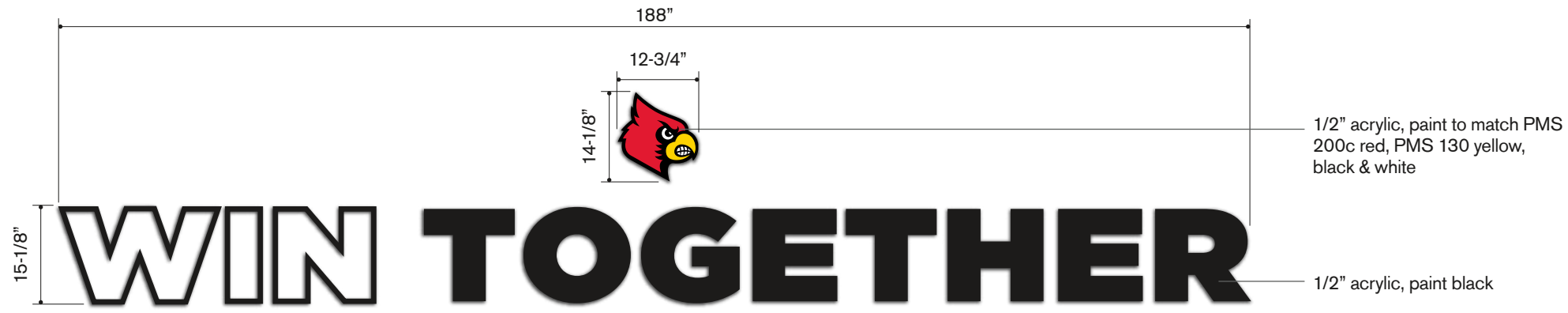

**DIMENSIONAL LETTERING/LOGO**

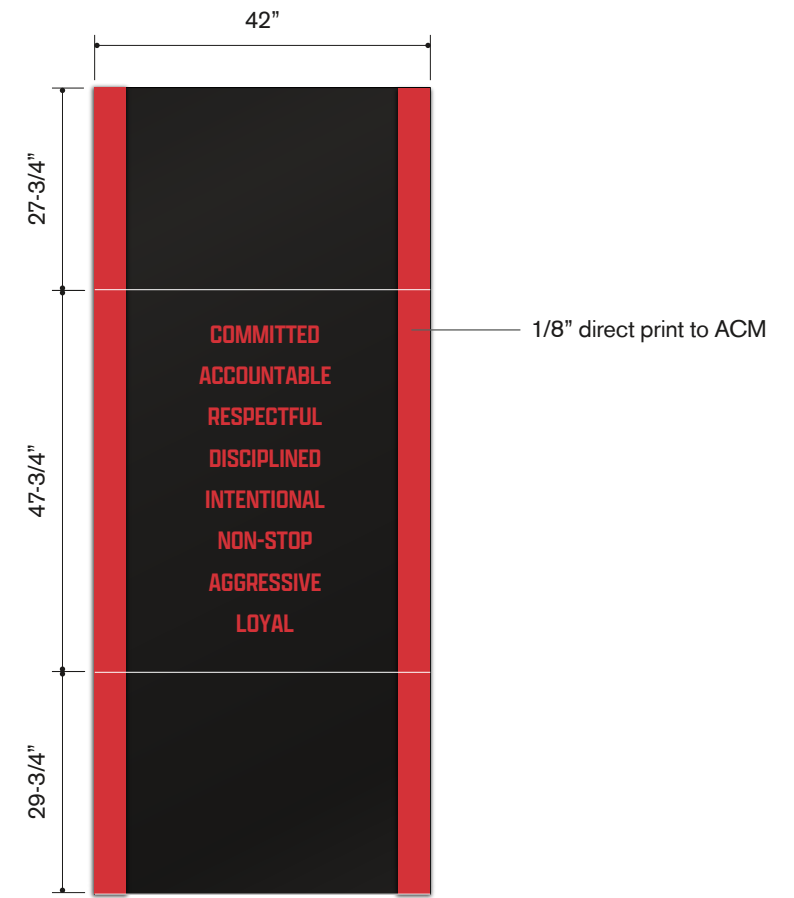

**WALL PLAQUE**

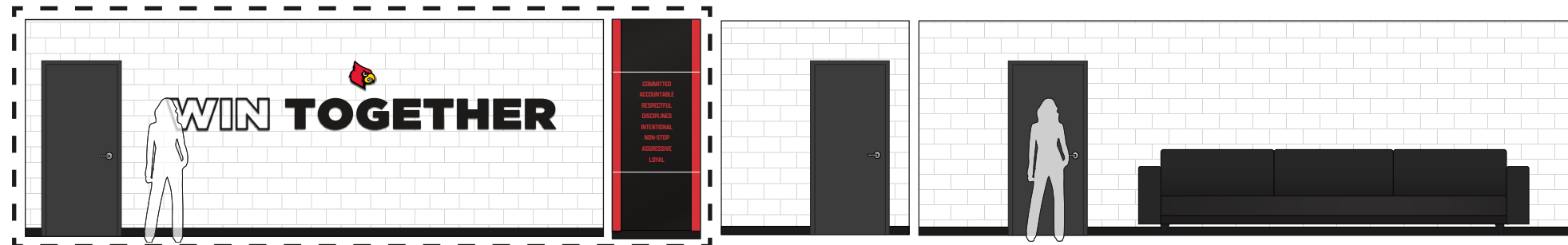

**PANORAMIC**



**LOCATION // LEVEL 1**

# WOMEN'S LOCKER ROOM



Paint black (by UL)

Paint black (by UL)

Dimensional logo



RENDERING

LOCATION // LEVEL 1

# WOMEN'S LOCKER ROOM



1/2" acrylic, paint to match  
PMS 200c red, PMS 130  
yellow, black & white

**DIMENSIONAL LOGO**



**LOCATION // LEVEL 1**



# TEAM DINING

Wall graphic

85" TV (by UL)



ELEVATION // **OPTION 1**



RENDERING

Paint black (by UL)

85" TV (by UL)

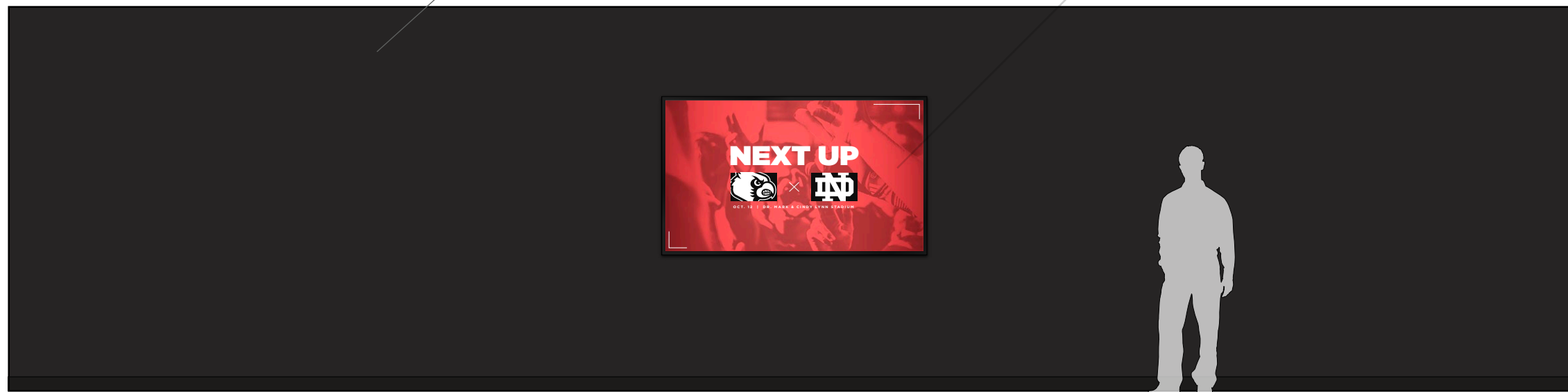

ELEVATION // **OPTION 2**



LOCATION // **LEVEL 1**

# TEAM DINING

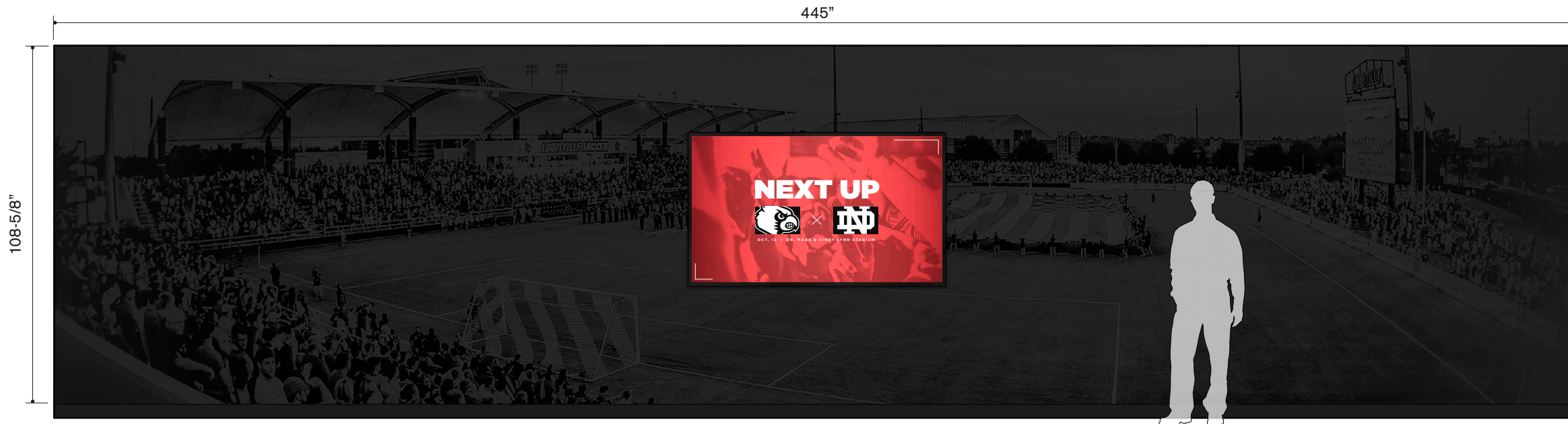

**ROUGH WRAP VINYL // OPTION 1**



**RENDERING**



**LOCATION // LEVEL 1**

**RECRUITING LOUNGE // NORTH ELEVATION**

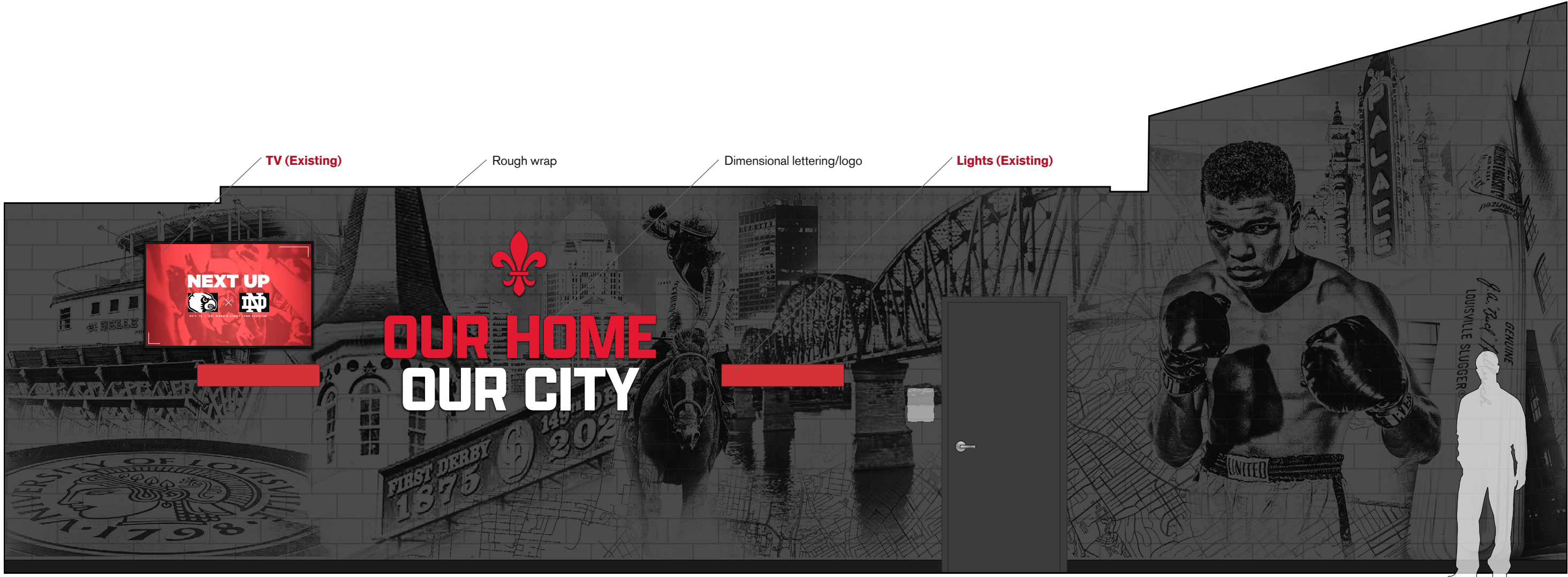

**ELEVATION**

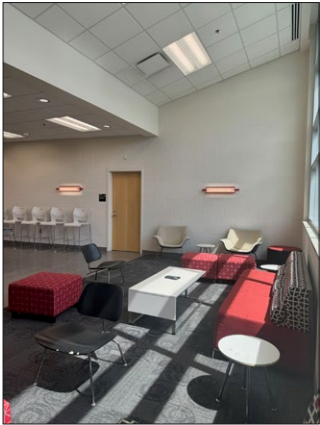
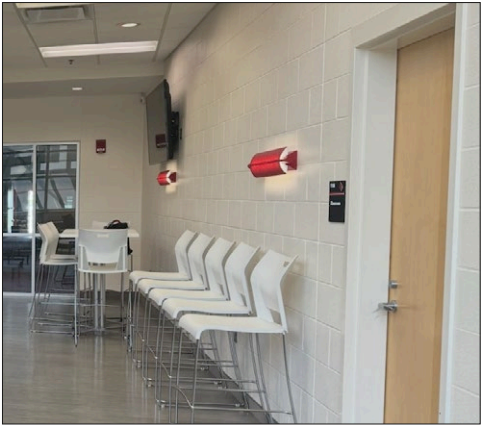

**LOCATION // REFERENCE**

**LOCATION // LEVEL 1**

# RECRUITING LOUNGE // NORTH ELEVATION

481"

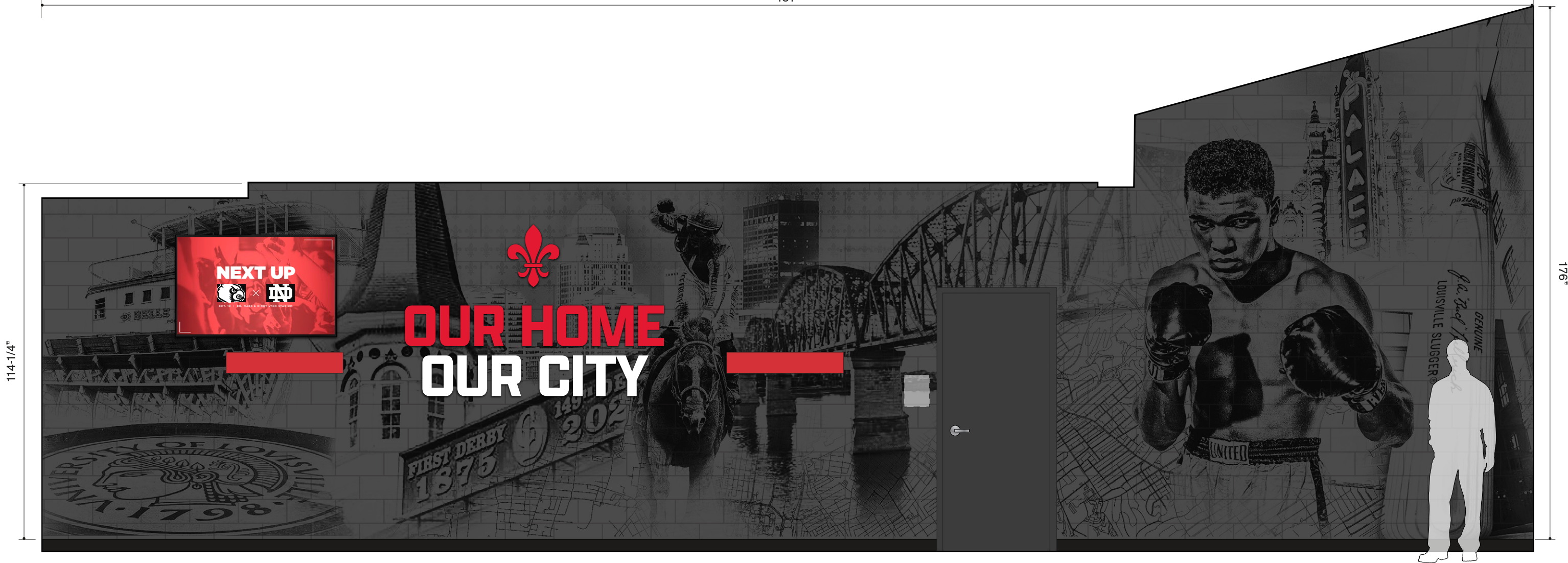

ROUGH WRAP VINYL

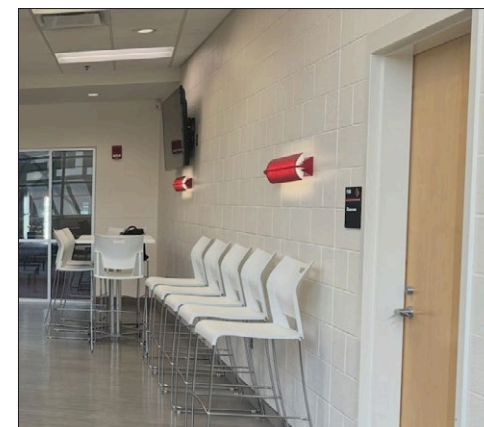
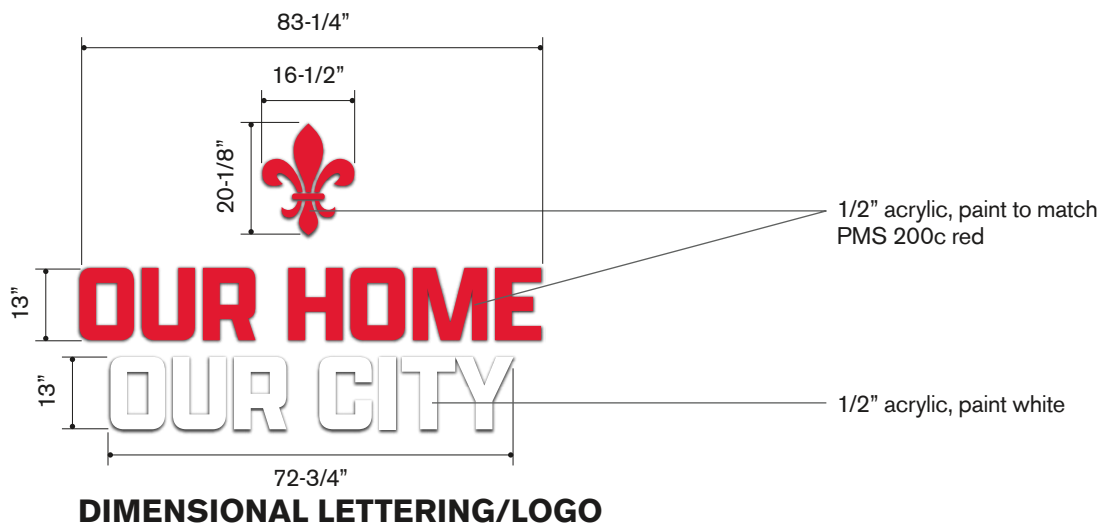

LOCATION // REFERENCE



LOCATION // LEVEL 1

**RECRUITING LOUNGE // SOUTH ELEVATION**

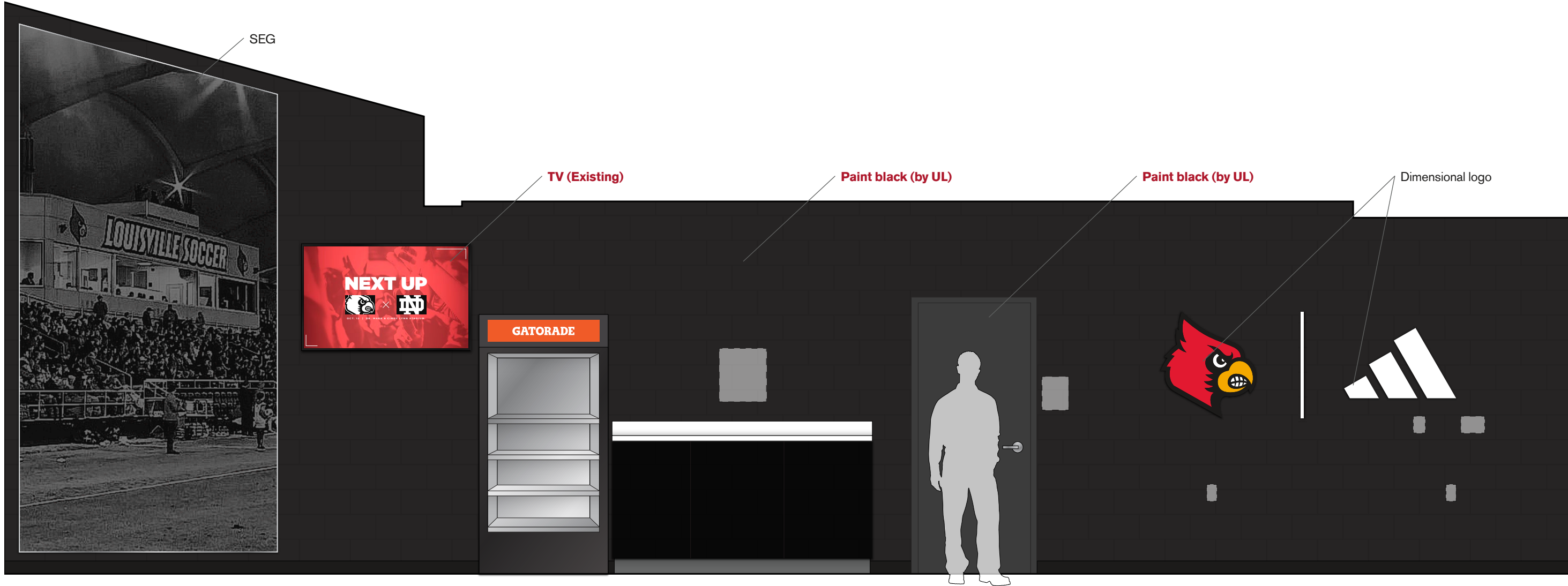

**ELEVATION // OPTION 2**



**LOCATION // REFERENCE**



**LOCATION // LEVEL 1**

# RECRUITING LOUNGE // SOUTH ELEVATION

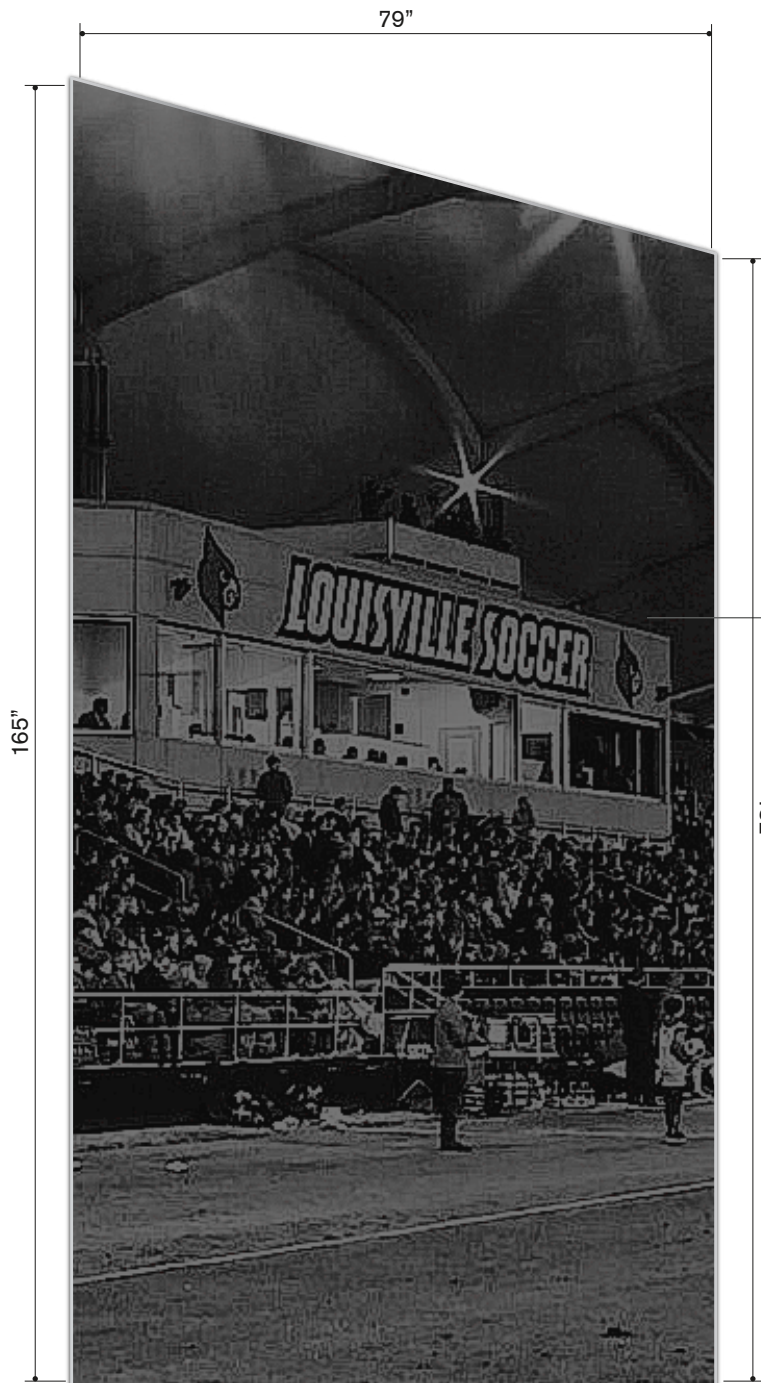

1.5" deep silicone edge fabric graphic frame, satin anodized returns

**SILICONE EDGE FABRIC FRAME**

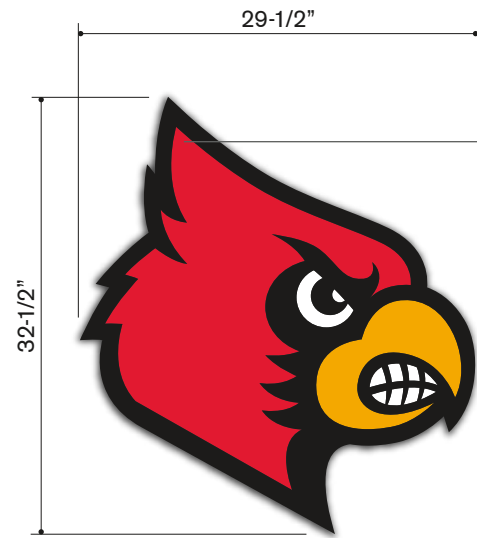

**DIMENSIONAL LOGO**

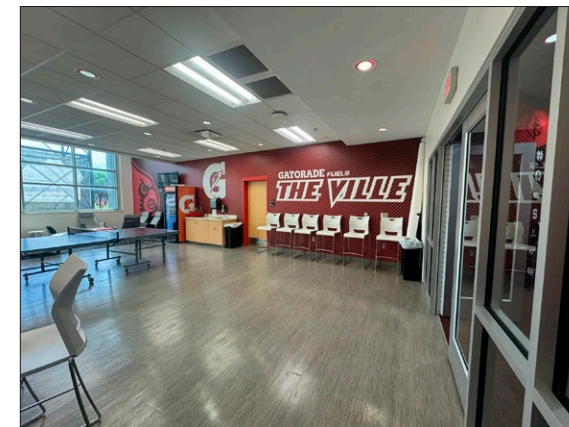
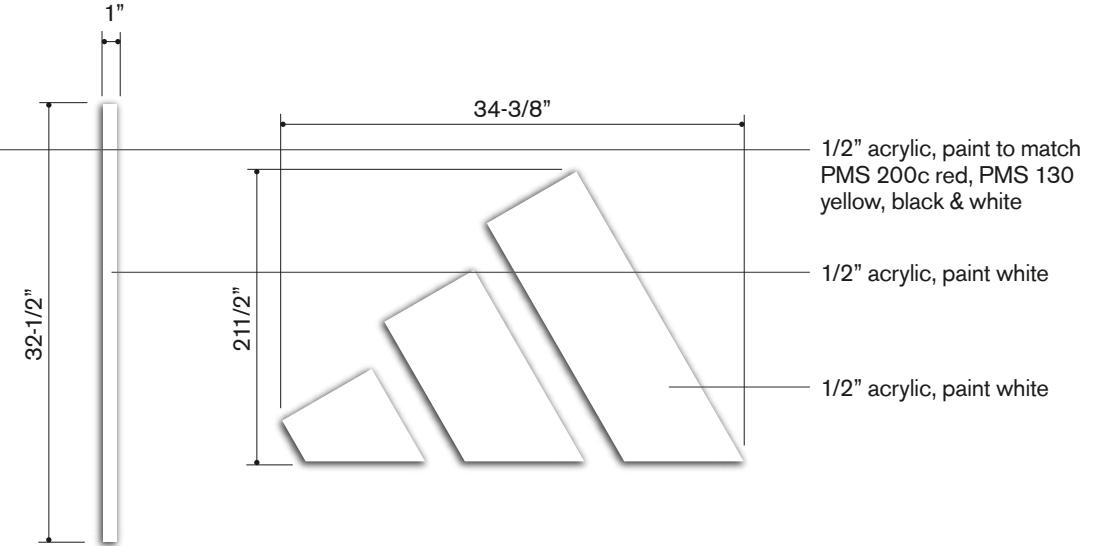

**LOCATION // REFERENCE**



**LOCATION // LEVEL 1**

# TRAINING ROOM



Paint black (by UL)

Paint red (by UL)

RENDERING



LOCATION // LEVEL 1

# CLASSROOM



ELEVATION // NORTH



RENDERING



LOCATION // LEVEL 1



# CLASSROOM

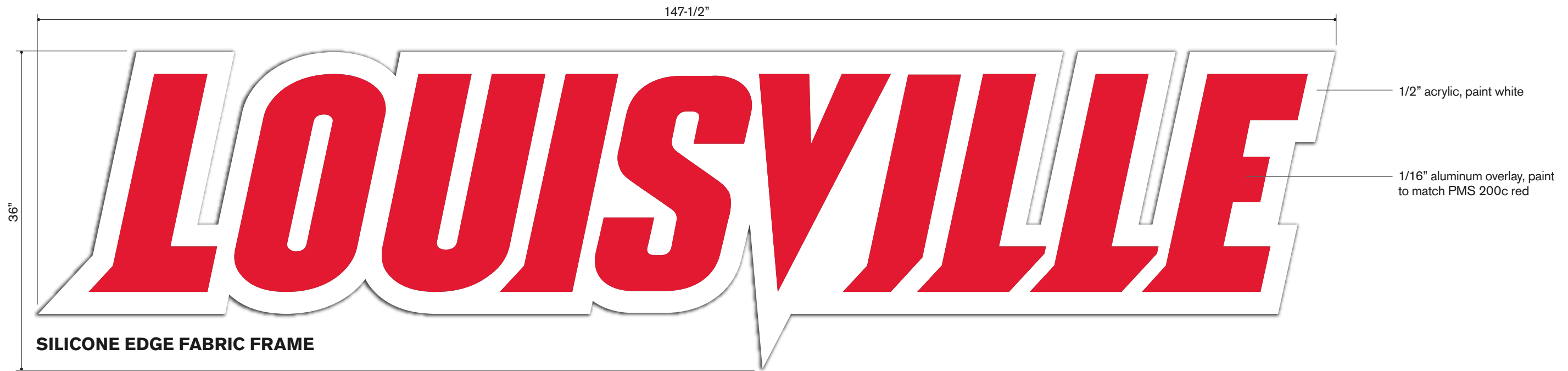

RENDERING



LOCATION // LEVEL 1

# MEN'S TEAM LOUNGE



ELEVATION // NORTH

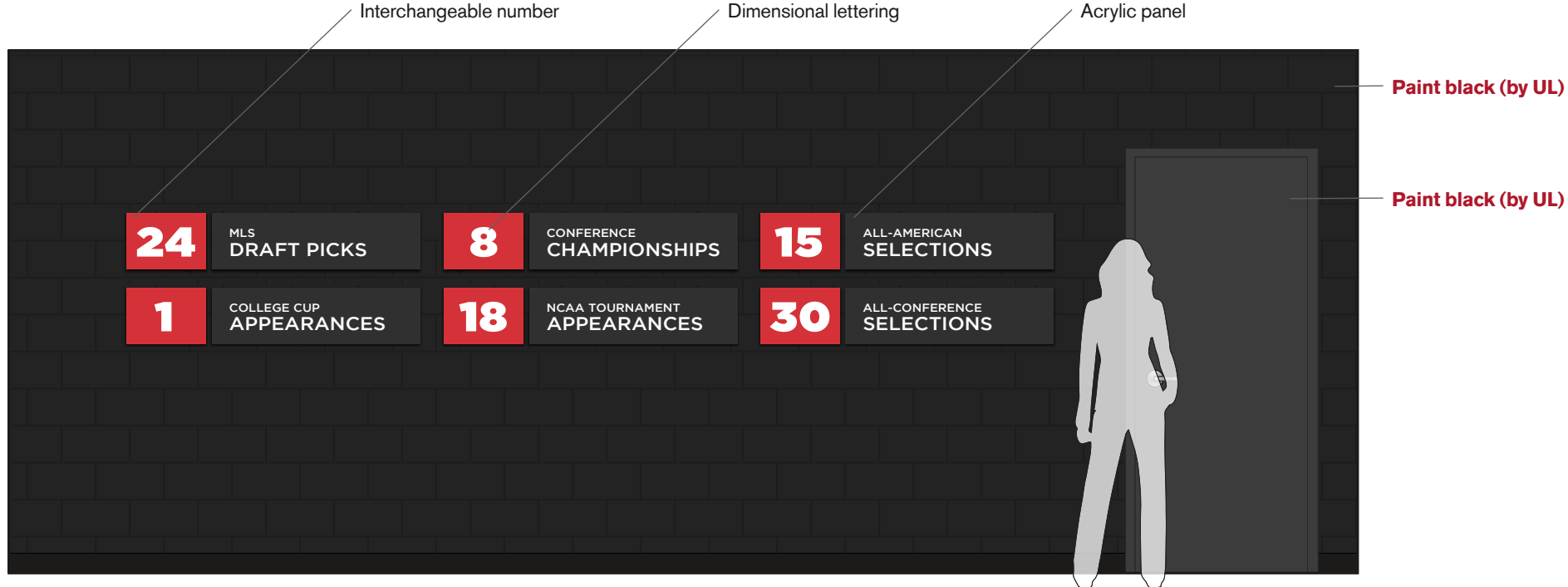

ELEVATION // SOUTH

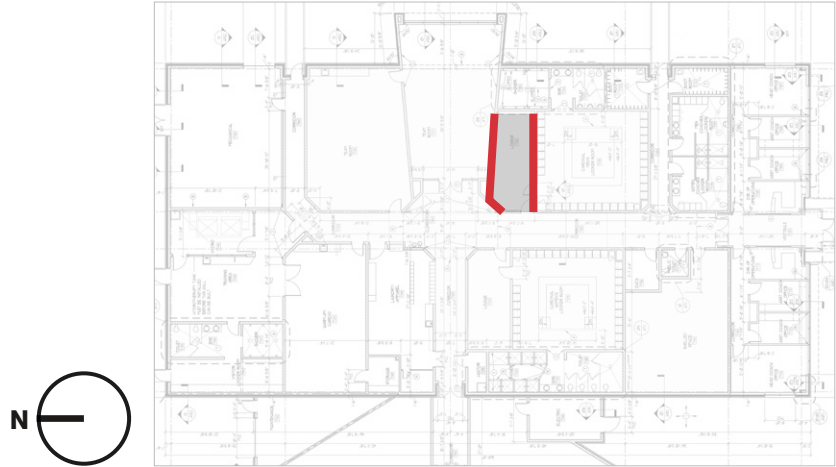

LOCATION // LEVEL 1

# MEN'S TEAM LOUNGE

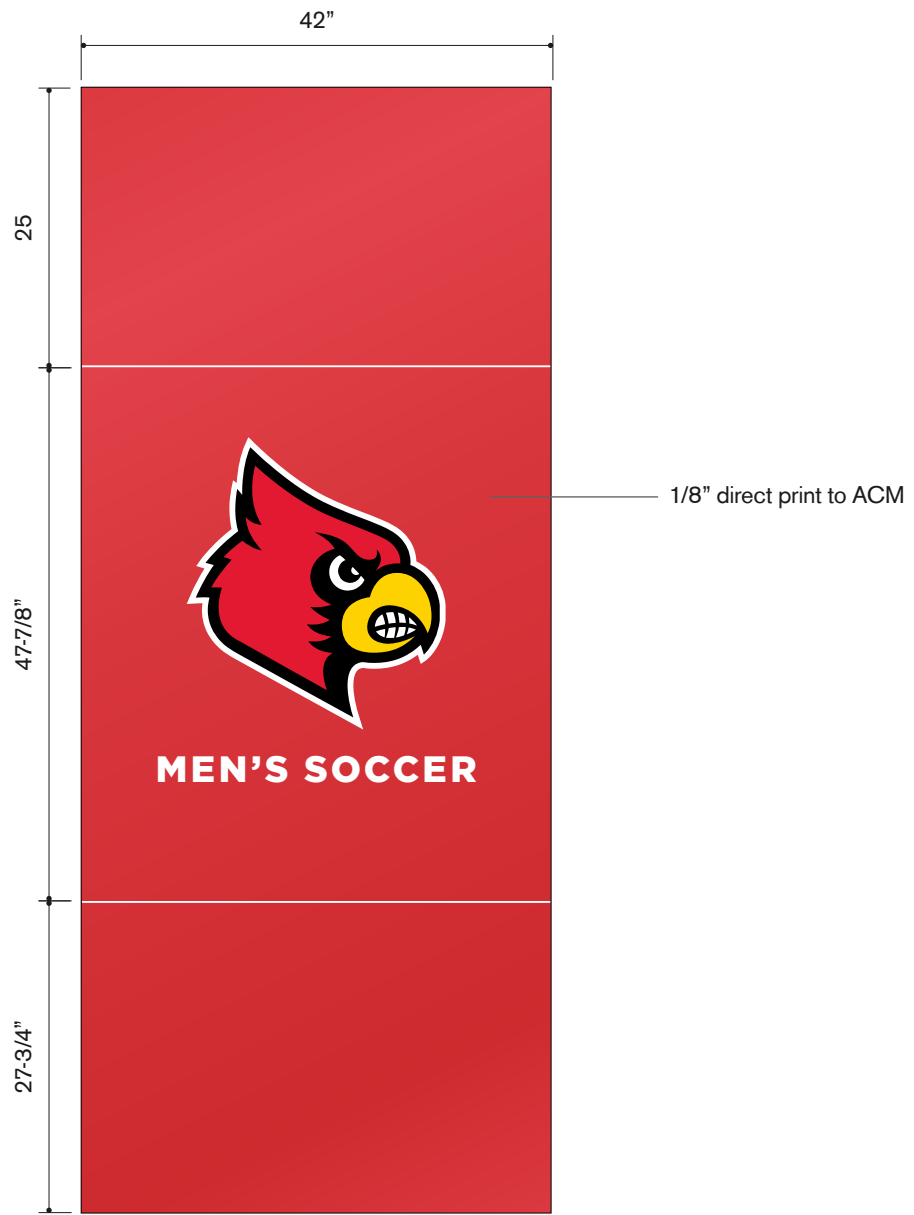

**DIMENSIONAL PLAQUE**



**DIMENSIONAL ACCOLADES**  
**QTY = 6 SETS**

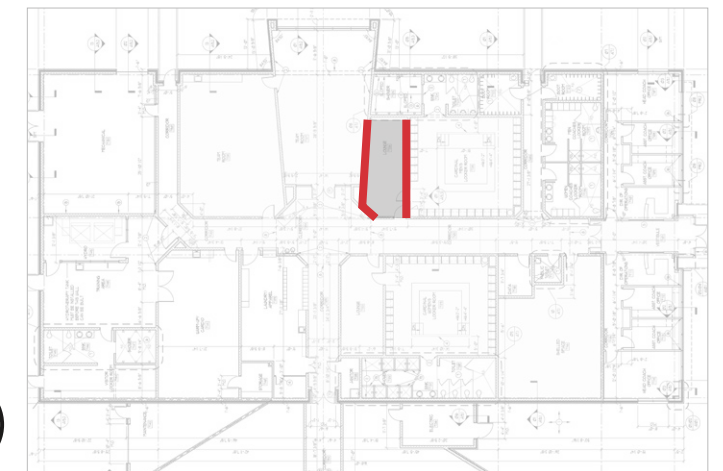

**LOCATION // LEVEL 1**