

Vice President/CIO
Information Technology
Information Technology

Senior Director
Information Systems
Customization & Upgrade
Data Warehousing
Enterprise Projects Other
Production Support
Change Management

Director
Enterprise Security
Security Infrastructure
Vulnerability Mitigation
Compliance
Investigations
Risk Analysis
Standards, Policies
Awareness
SDLC Security
Tech Support
Middleware
Enterprise Operations
Disaster Recovery
Capacity Planning
Facilities Management
Disk Storage
Secure Access Mgmt

Project Manager
Project Management

Communication & Marketing-

Admin Director
VPIT Support
Admin
Finance
HR

Director
Communication Services
Network Management
Special Projects
Voice Services Admin
Network Facilities
Billing & Admin
Digital Signage

Asst. Director
Consulting
iTech Connect
Help Desk
Documentation & Trng
Client Partners
Research & Development

Asst Vice President
Support Services

Director
Research Support

Asst. Director
Next Gen Services
Interactive Applications
Digital Assets
Document Management
Digital Media Lab

Interim Project Manager
Project Management

Asst. Director
Student & Classroom Svcs
iTech Xpress
User Centers
Lab Management
Classroom Support
Desktop Support

Director
Creative Services
Printing
Copier Management

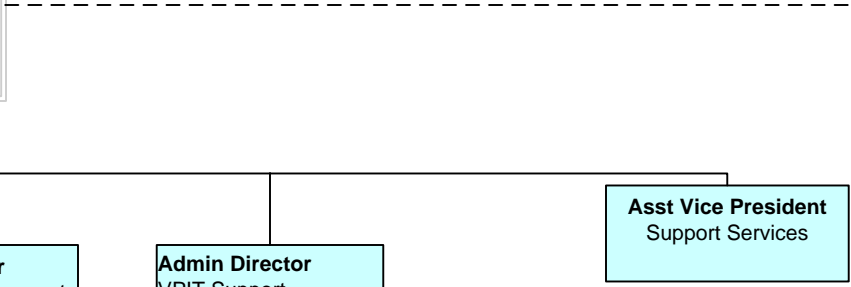

Vice President/CIO
Information Technology
Priscilla Hancock

Enterprise Security
Director
Brenda Gombosky

Name: Dave Richards
Title: Ent Sys Anal III

Tech Support Team
Asst Dir
Deepak Sharma

Secure Access Mgt
Interim Team Ldr
Laura Davis

Enterprise Security
Interim Asst
Director
Alice Radmacher

Name: Andrea Williams
Title: Ent Progr Anal III

Name: Dave Ehresman
Title: Ent Sys Progr IV

Name: Rohini Sharma
Title: Ent Sys Progr III

Name: Dave Jones
Title: Ent Sys Progr IV

Name: Scott Owen
Title: Ent Sys Progr II

Name: Brad Andersen
Title: Ent DataBase Anal Sr

Name: Eric Lair
Title: Ent Sys Progr III

Name: Kevin Chinn
Title: Ent Sys Progr IV

Name: Larry Bradley
Title: Ent Sys Progr IV

Name: Phil Burris
Title: Mgr Dis Recovery

Name: Tim Boyle
Title: Project Mgr

Name: Robin Houze
Title: Tech Lead (DBA)

Name: Kevin Batman
Title: IEnt Dbase Anal

Name: Maria Kapalczynski
Title: Ent Dbase Admin

Name: Lisa Lindsey
Title: Admin Sys Anal

Name: Charlie Rademaker
Title: Ent. Progr Anal II

Name: Vacant
Title: Student Intern

Name: Lisa Cooper
Title: Ent Security Anal III

Name: Andrew Davis
Title: Ent Security Anal IV

Name: Matthew Price
Title: Ent Security Anal III

Name: Jacob Jeffers
Title: Ent Sec Anal I

Name: Student
Title: Student Intern

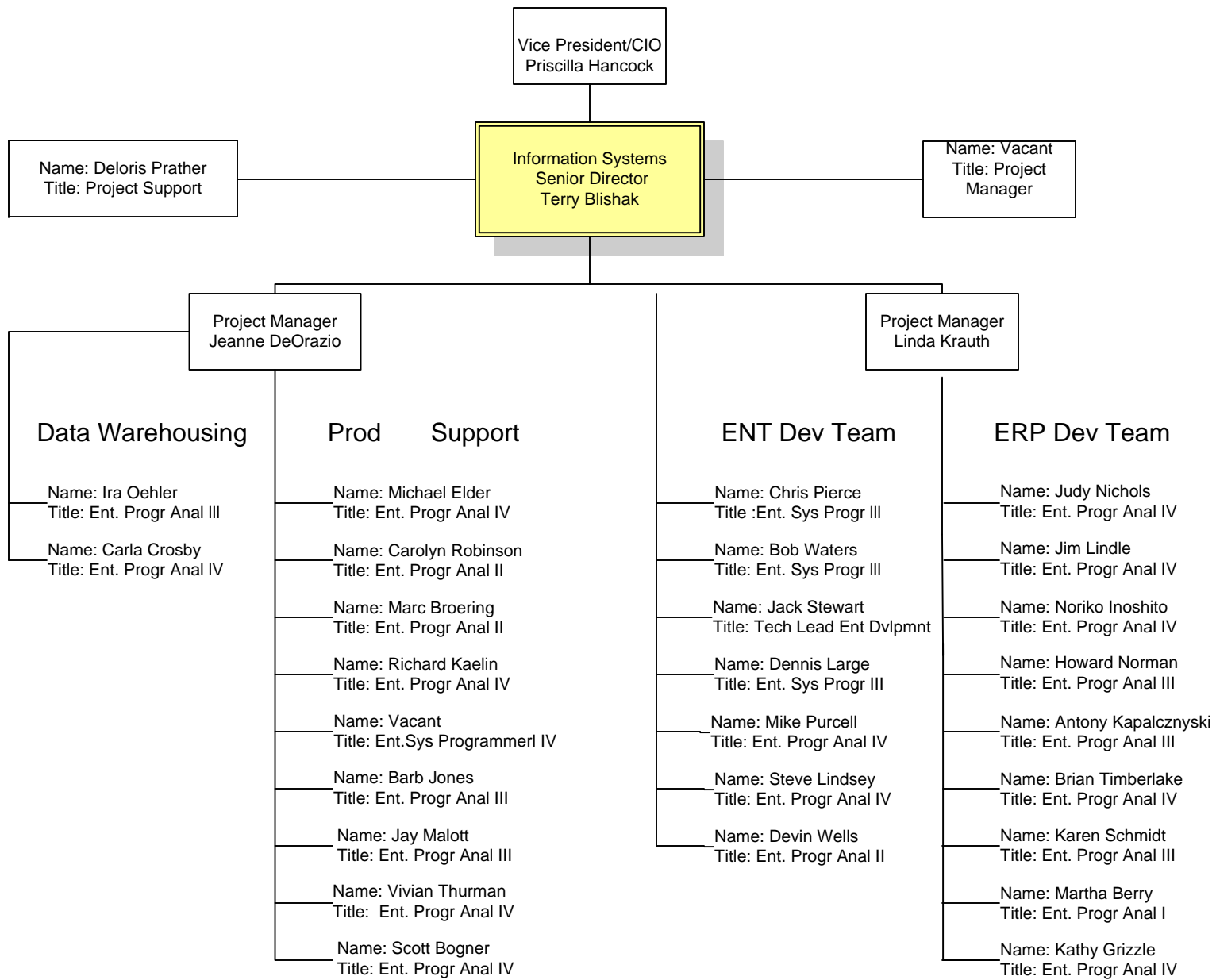

Support Services
Assistant Vice President
Sande Johnson-Byers

Communication Services
Director
Jo Kaelin

Asst Dir
Bo Lowrey

Customer Support & Admin
Denita Campo

Customer Appl Team
Kevin Condit

Comm Network Facilities
Kevin Condit

Libby Davis
Admin Assoc

Network Planning &
Management
Dave Cox

- Name: Kim Peckinpaugh
Title: Comm Analyst Sr
- Name: Bob Gueltzow
Title: Comm Analyst III
- Name: Mary McCormick
Title: Comm Consultant
- Name: Rita Nathaniel
Title: Comm Analyst II
- Name: Faye Holmes
Title: Comm Analyst II
- Name: Kathy Sullivan
Title: Comm Anlyst, Sr
- Name: Karin Tyler
Title: Comm Analyst III

- Name: Brent Pollock
Title: VoIP Network Admin
- Name: Vacant
Title: Comm Analyst II
- Name: Vacant
Title: Tech Conslt 1

- Name: Eddie Lemon
Title: Team Leader
- Name: Patrick Duvall
Title: Network Svcs Tech III
- Name: Earl Harrison
Title: Network Svcs Tech II
- Name: Mark Patrick
Title: Network Svcs Tech III
- Name: David Niehoff
Title: Network Svcs Tech III
- Name: Chris Hennessey
Title: Network Svcs Tech II
- Name: Trent Hurt
Title: Wireless Ntwk Admin
- Name: Vacant
Title: Wireless Ntwk Admin
- Name: Shawn Fread
Title: Network Svs Tech II
- Name: Vacant
Title: Svs Tech II

- Name: Hans Fiedler
Title: Network Anal Sr
- Name: Kevin Shively
Title: Network Anal Sr.

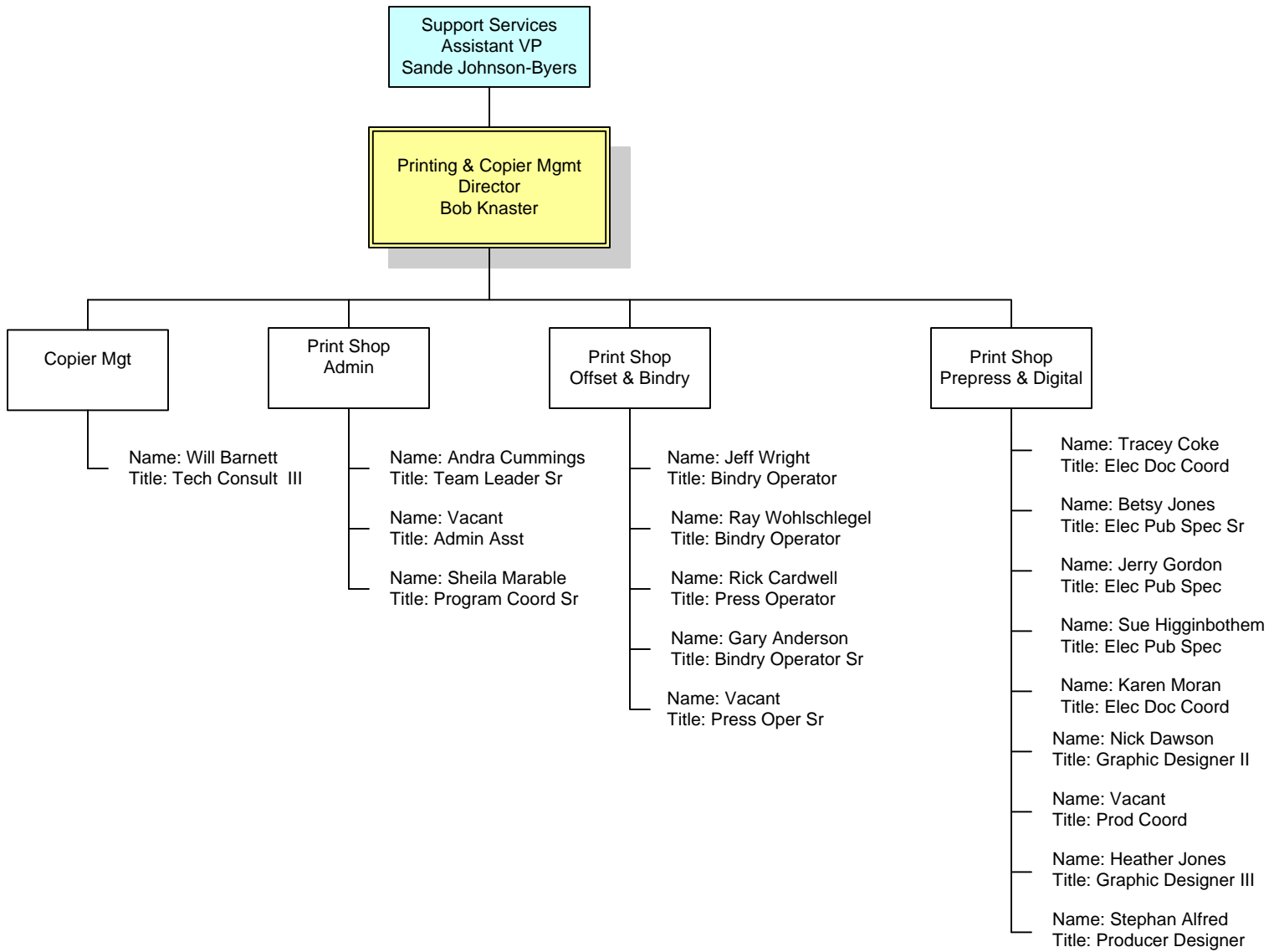

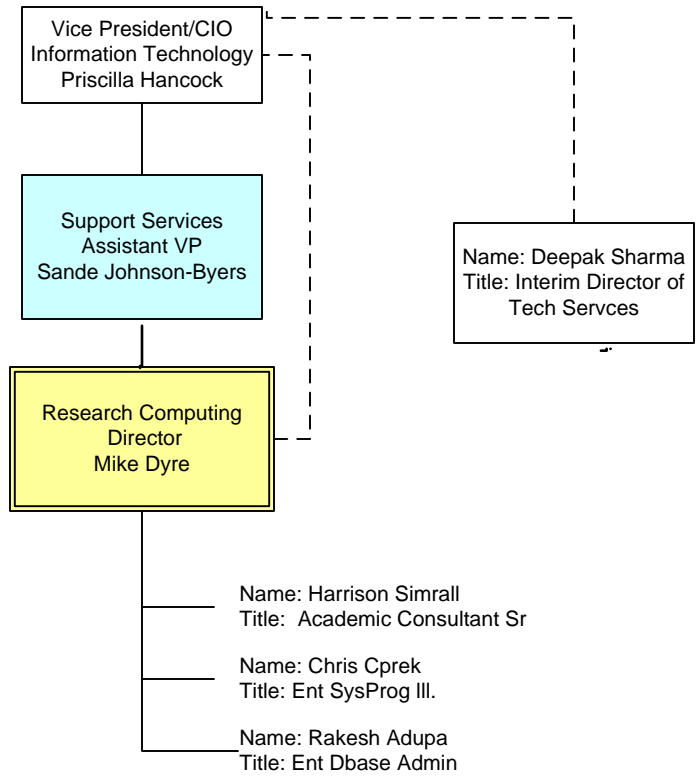



Support Services
Assistant VP
Sande Johnson-Byers

Consulting
Asst. Director
Pam Frank

Help Desk
Karen Johnson

- Name: Carolyn Drury
Title: Ops Ctr Spec II
- Name: Cliff Krause
Title: Op Ctr Spec II
- Name: Steve Manning
Title: Op Ctr Spec II
- Name: Vacant
Title: Op Ctr Spec II
- Name: Cheryl Monroe
Title: Op Ctr Spec II
- Name: Barbara Fish
Title: Ops Ctr Spec I
- Name: Lisa Peacock
Title: Op Spec I.
- Name: Tim Caswell
Title: Op Ctr Spec II
- Name: Sharon Abernathy
Title: Ops Ctr Spec II
- Name: Victoria Boyd
Title: Ops Ctr Spec II
- Name: Christina Dennis
Title: Ops Ctr Spec I

Itech Connect
Karen Johnson

- Name: Marc Echternach
Title: Comm Analyst II
- Name: Sharon Jhoslien
Title: Inst. Tech. Consult Sr
- Name: Amer Asmar
Title: Student Intern

Strategic Planning
Vicki Harpe

Client Partners
Susan Barber

Name: Janet Valentine
Title: Instr Tech Cons Sr.

R & D
Troy Franklin

Name: M
Title: Tec

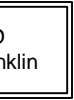

Name: Michael Radmacher
Title: Tech Con IV

|

Support Services
Assistant VP
Sande Johnson-Byers

Student &
Classroom Svcs
Asst Director
Rhonda Dixon

Desktop &
Classroom Support

Name: Jeff Booker
Title: Desktop Support Tech

Name: Darwin Hendrix
Title: Desktop Support Tech

Name: Jonathan Ledford
Title: Desktop Support Tech

Name: Steve Clemons
Title: Inst Tech Consultant

Name: Greg Rudd
Title: Casual/ Temp

Name: Michael Underwood
Title: Casual/Temp

Name: Mike Murphy
Title: Inst Tech Consultant

Name: Robert Peck
Title: Multimedia Tech II

Name: Richard Morris
Title: Tech Spclst 1

Name: Henry Smith
Title: Multimedia Tech II

Name: Ron Meeron
Title: Inst Tech Consultant

Name: Eric Heil
Title: Desktop Support Tech

Name: Vacant
Title Comp Support Anal Sr

Name: Ignacio Rojas Bravo
Title: Comp Support Anal

Desktop & Classroom
Suppo

Name: Michael Dennis
Title: Temp

Name: Moises Rodriguez
Title: Temp

User Center

Name: Donna Casey
Title: Tech Specialist

iTech Xpress
Manager
Lisa Payne

Name: Teresa Williams
Title: Tech Specialist Int

Name: Jim Travelstead
Title Tech Consultant IV

Name: Donna Casey
Title: Tech Specialist

Name: Ignacio Rojas Bravo
Title: Comp Support Anal

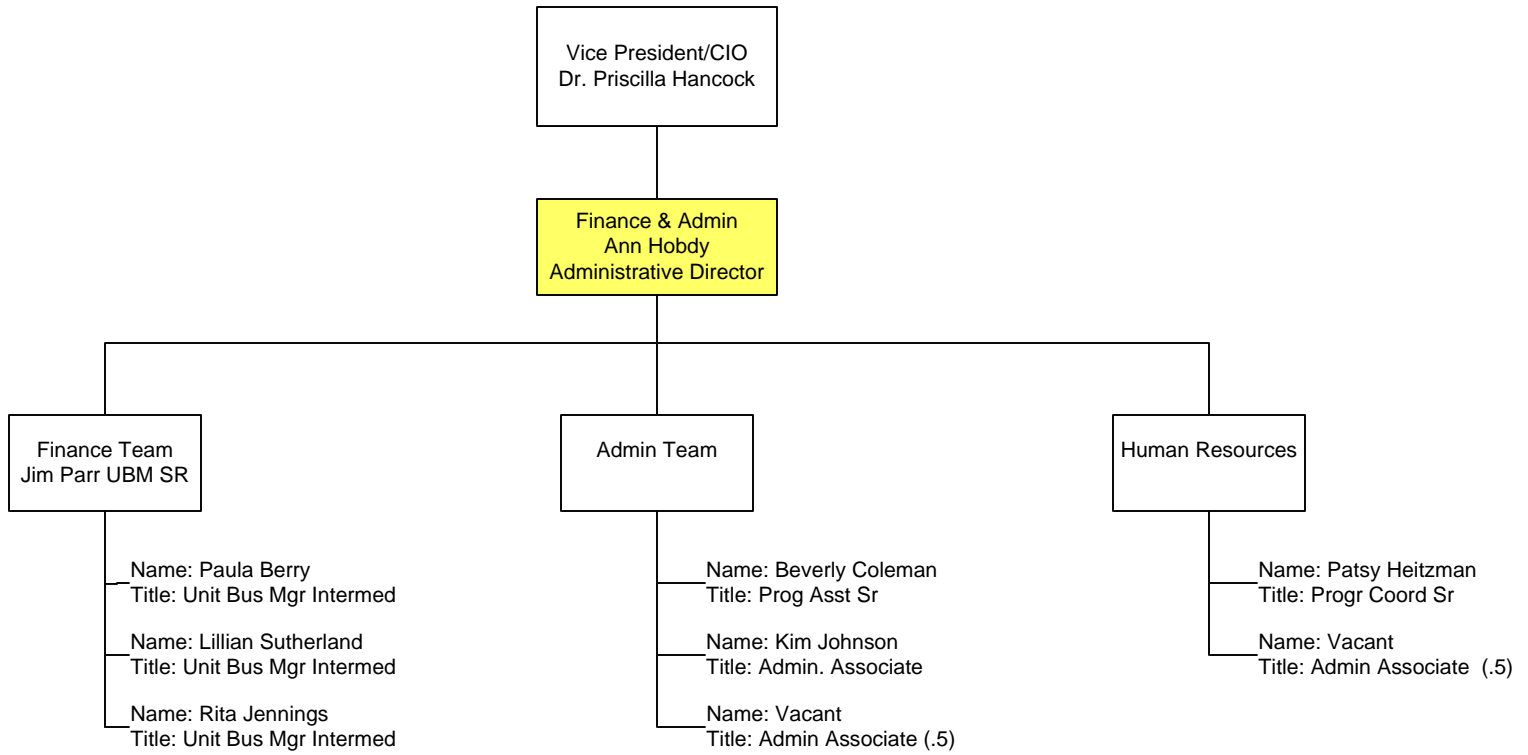

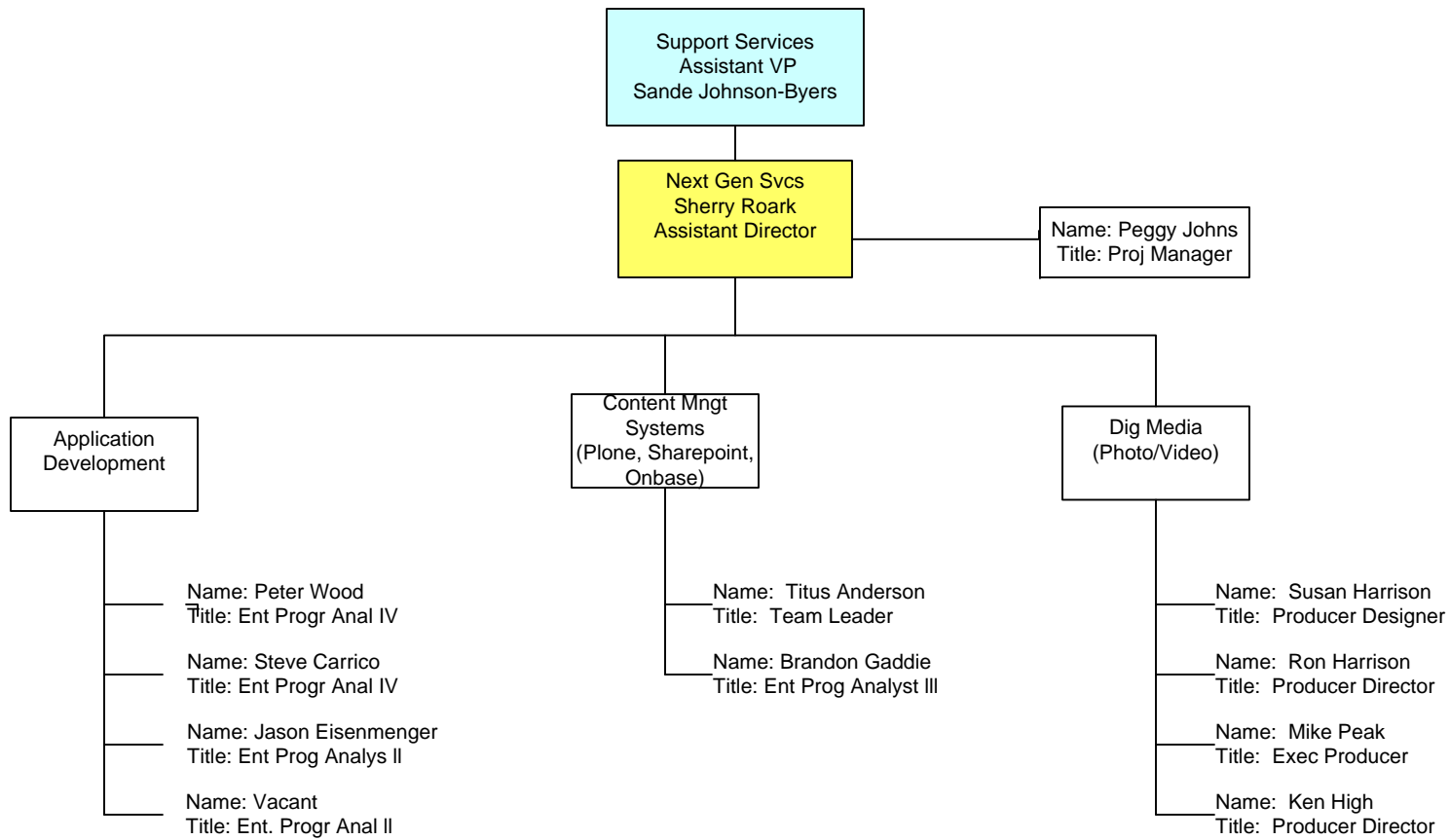

Vice President/CIO
Information Technology
Priscilla Hancock

Project Management
Project Manager
Laura Hardesty

Name: Halley Lynch
Title: Comm & Marketing Spec

Name: Phyllis Macina
Title: Admin Assoc.