

# Manual Ball Bonder Short Course

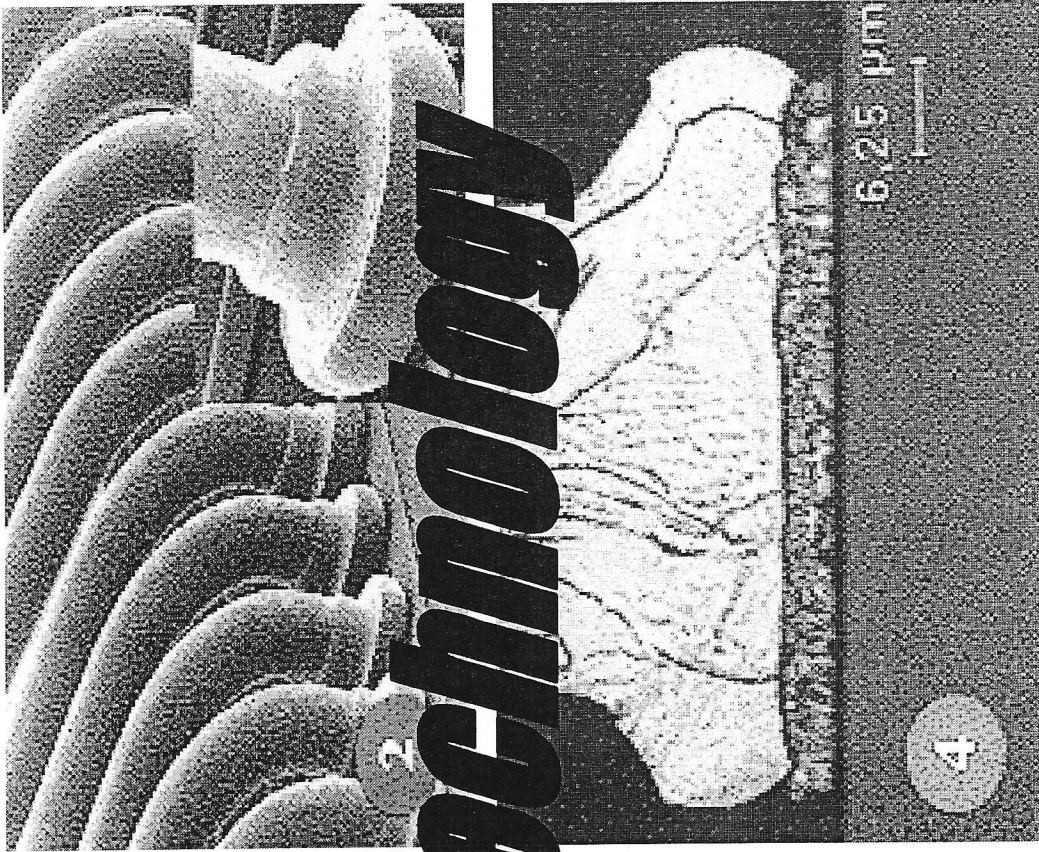

# BALL BOND TECHNOLOGY

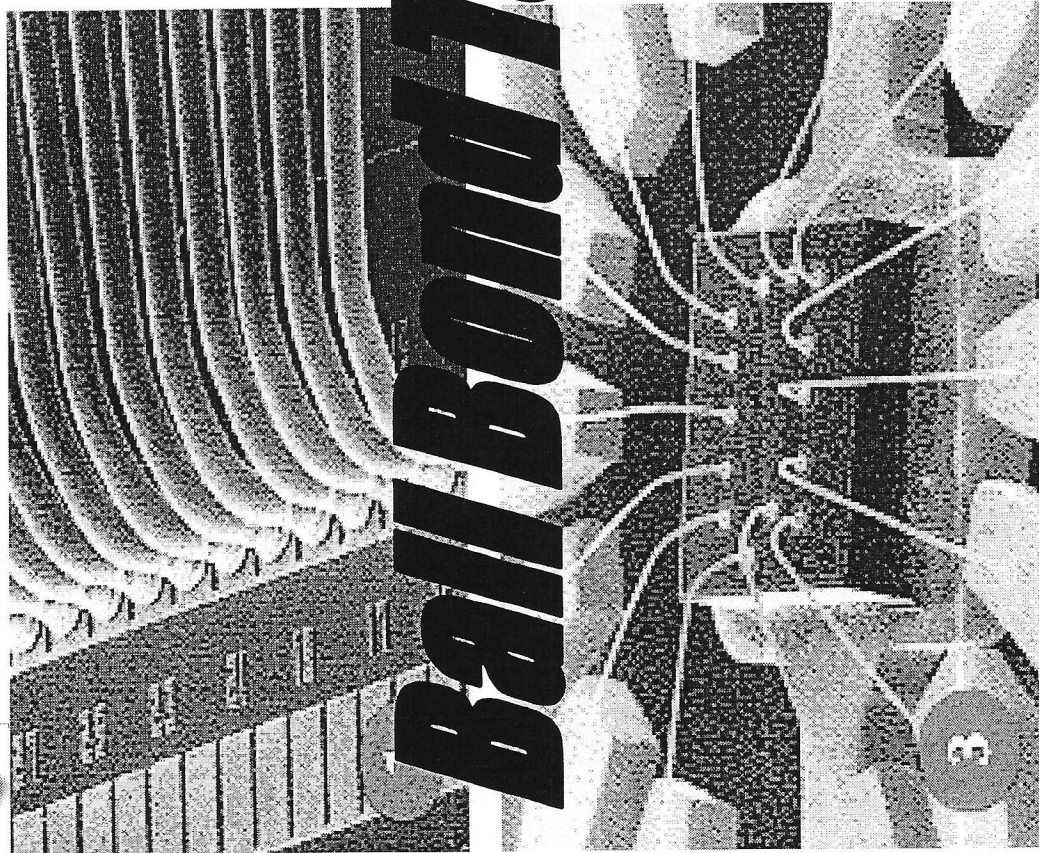
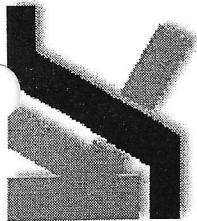

# Manual Ball Bonder Short Course

Wire: 0.0003" to 0.003" dia.  
Al or Au  
Substrate: 300°C  
Needle: 150°C  
Gas: N<sub>2</sub>

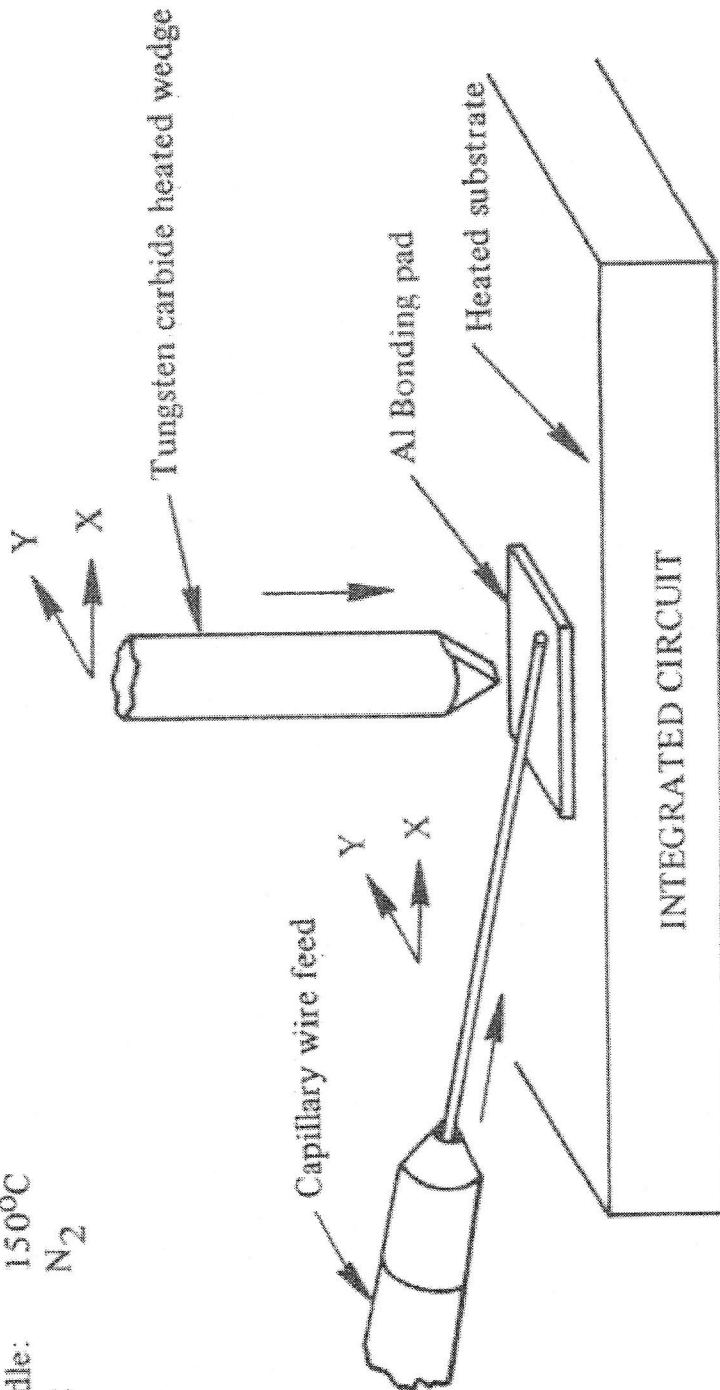

Wire Bonding c1957

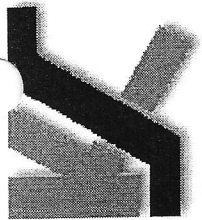

# Manual Ball Bonder Short Course

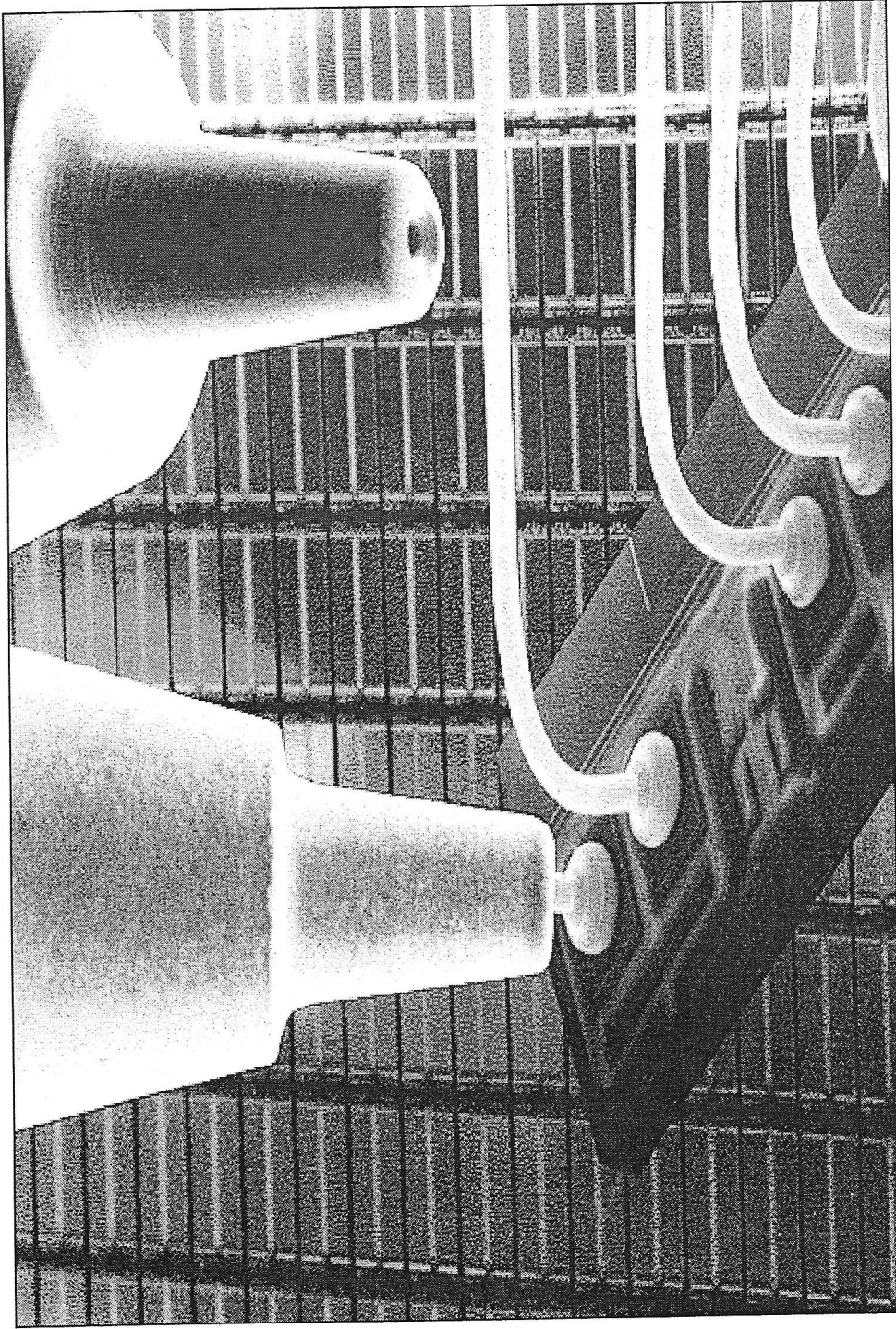

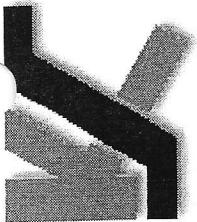

# **Manual Ball Bonder Short Course**

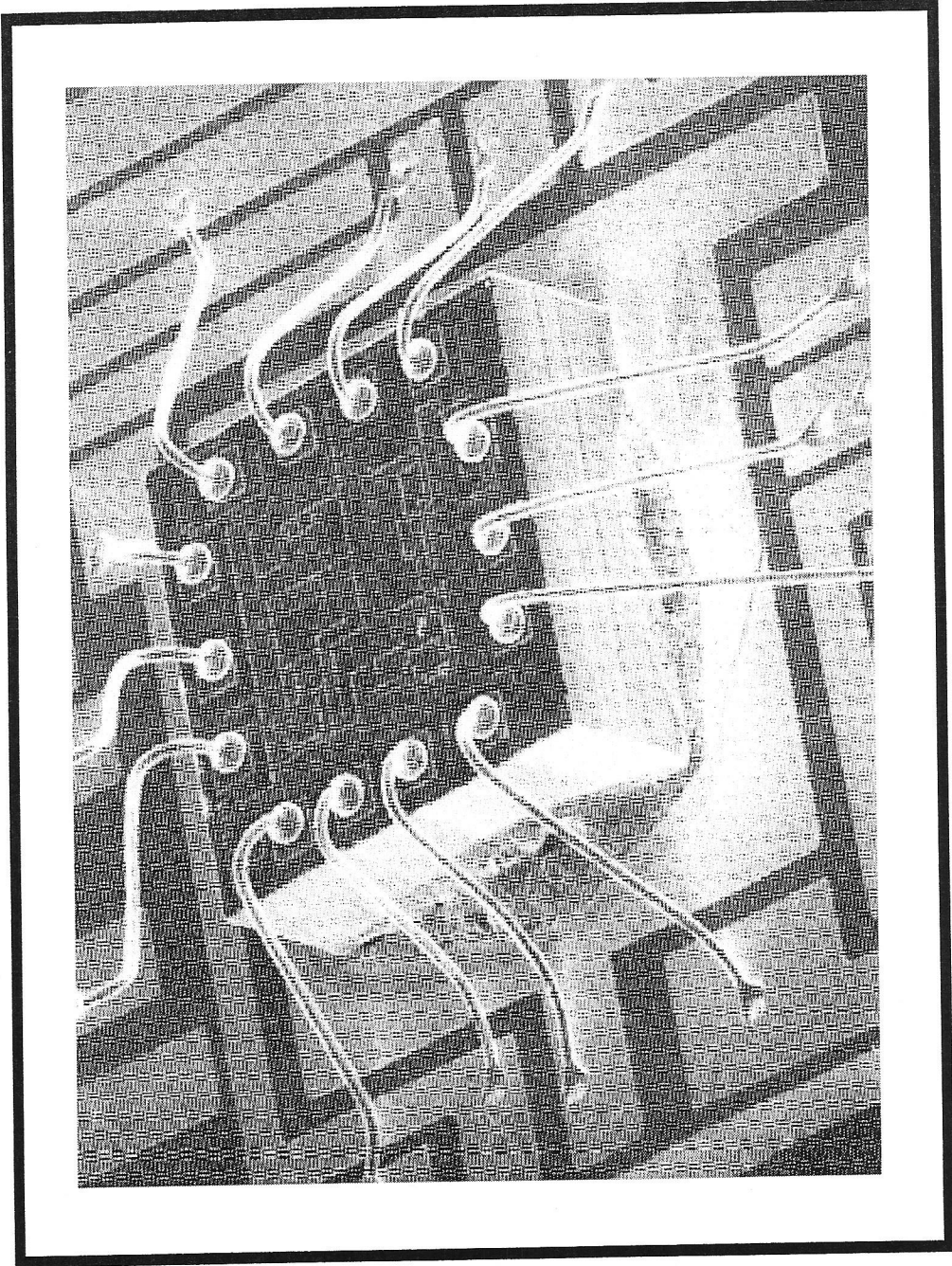

*Typical Small Integrated Circuit with Wires*

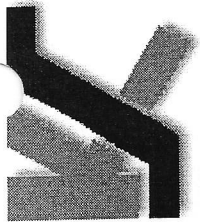

# **Manual Ball Bonder Short Course**

**Transducer Assembly  
with Capillary and  
Heater  
Coil for  
Thermocompression  
Ball Bonding**

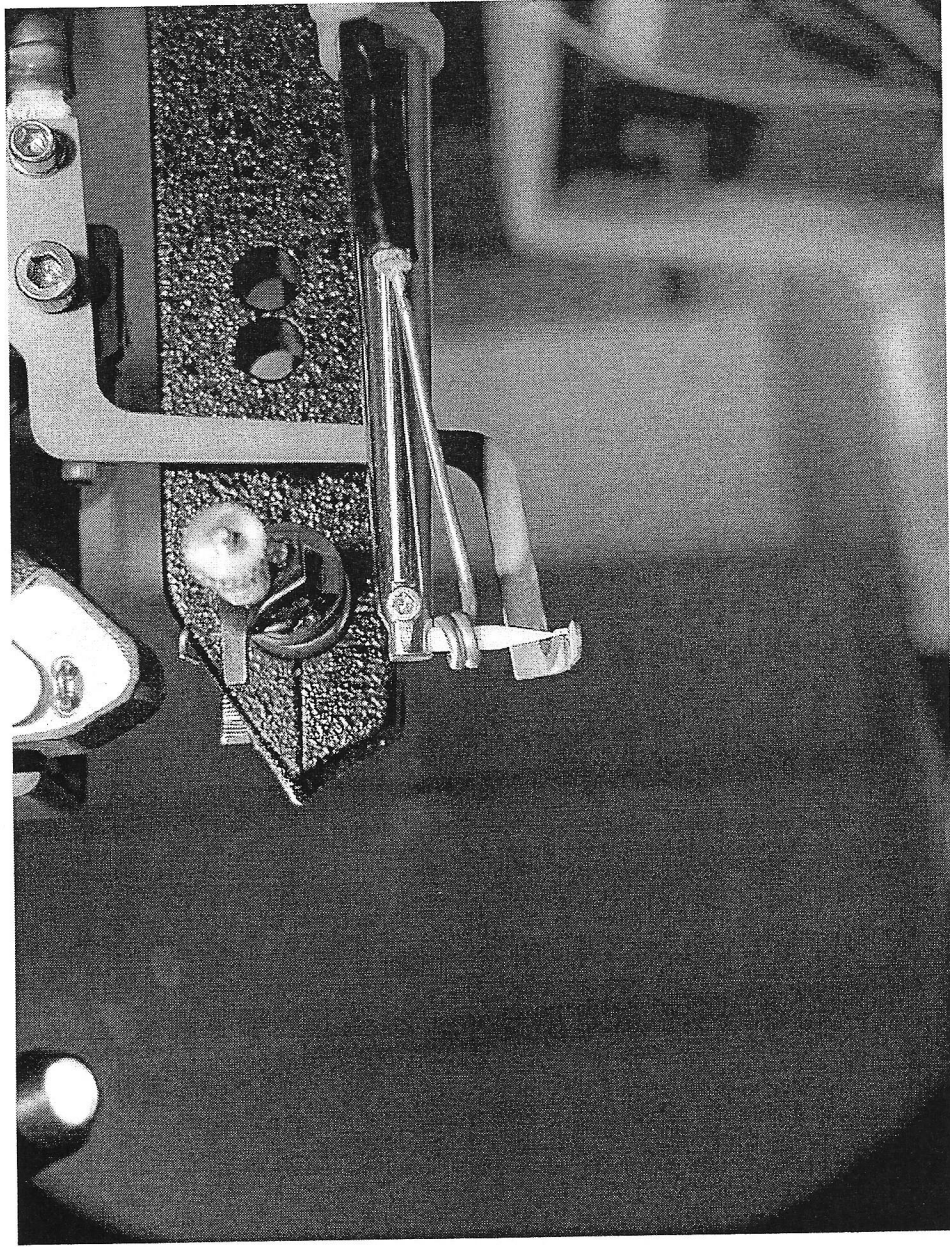

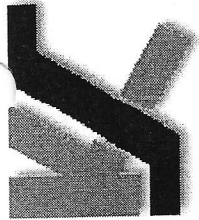

# Manual Ball Bonder Short Course

---

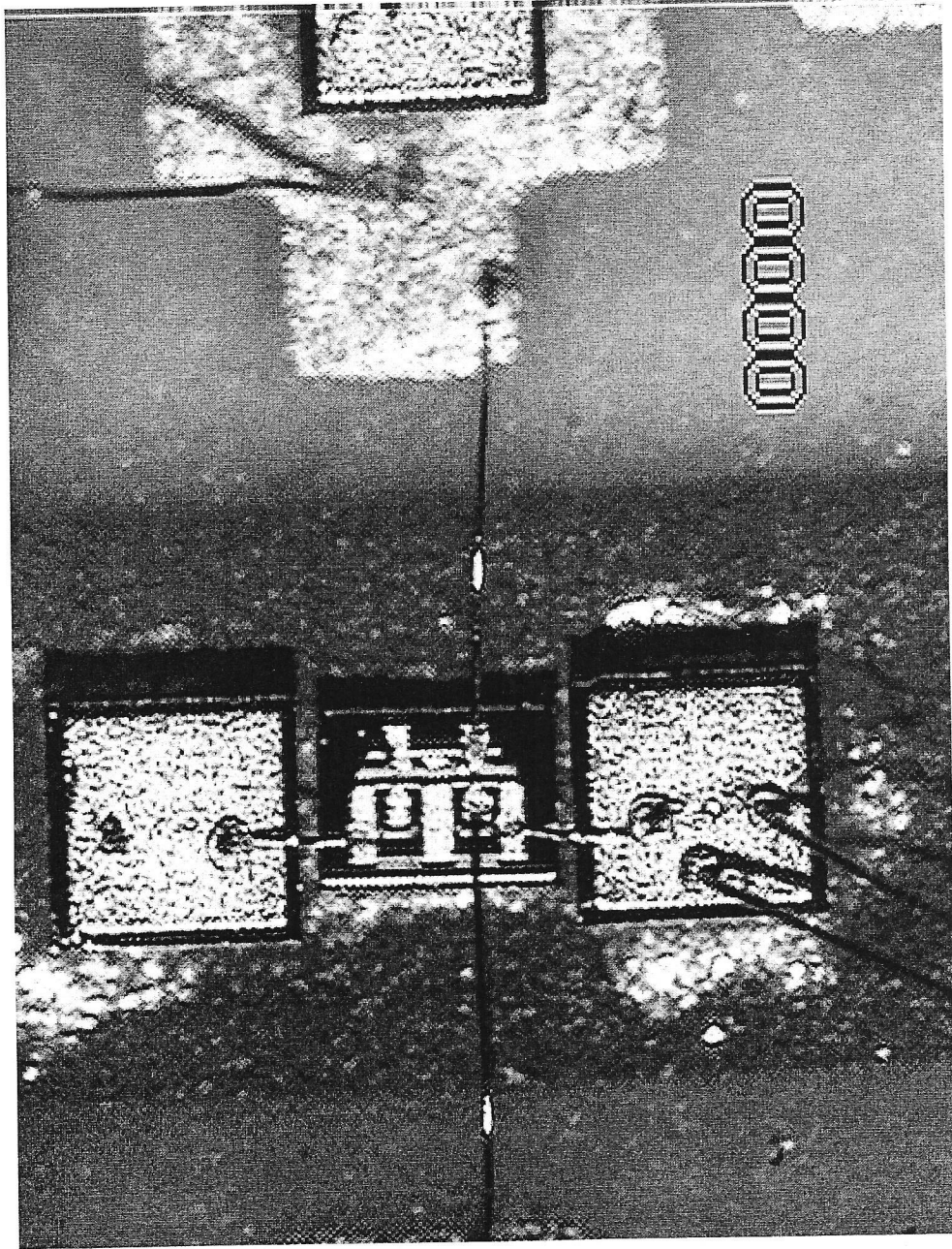

Gold Pads on Device



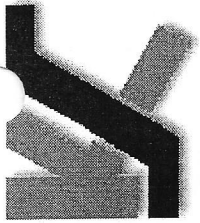

# **Manual Ball Bonder Short Course**

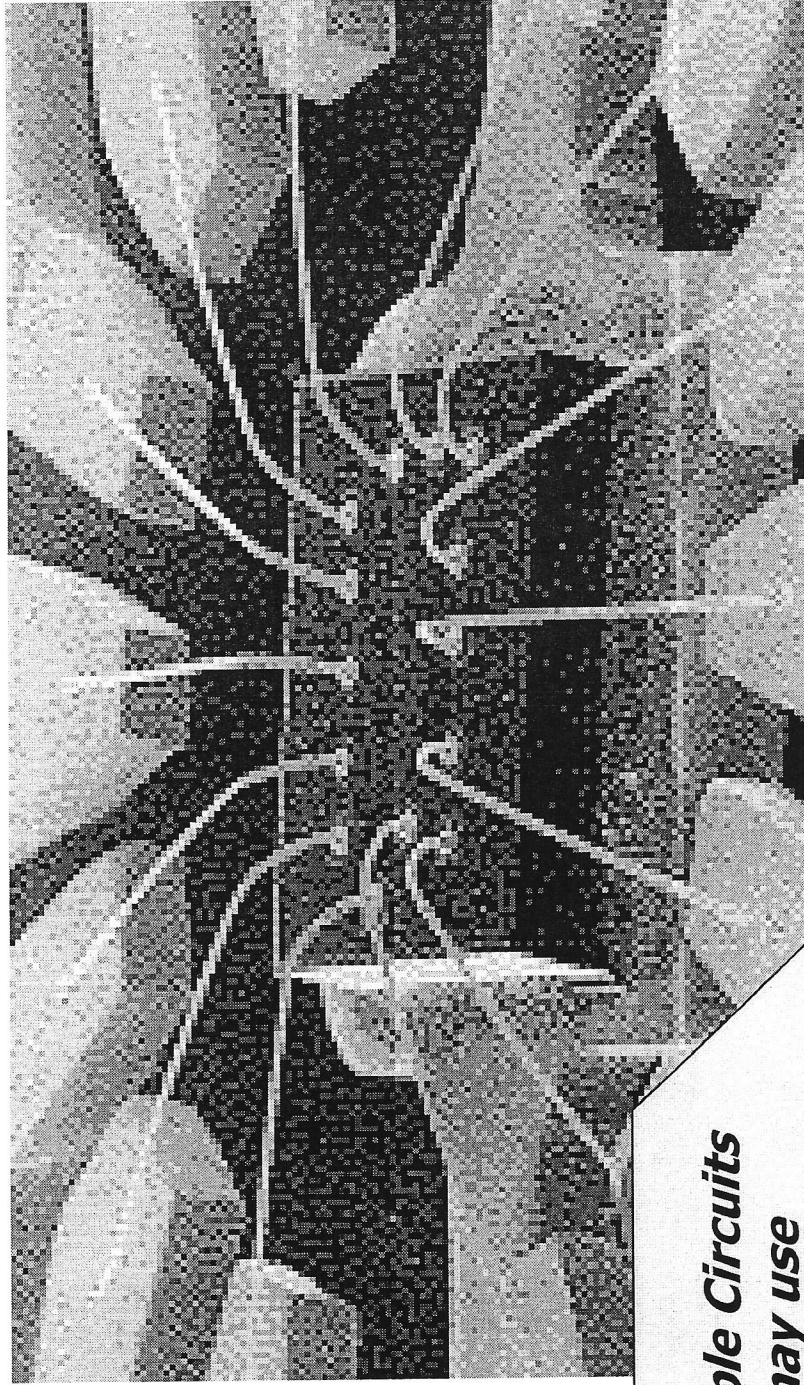

**Simple Circuits  
may use  
Thermocompression  
Bonding**

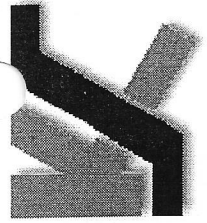

# Manual Ball Bonder Short Course

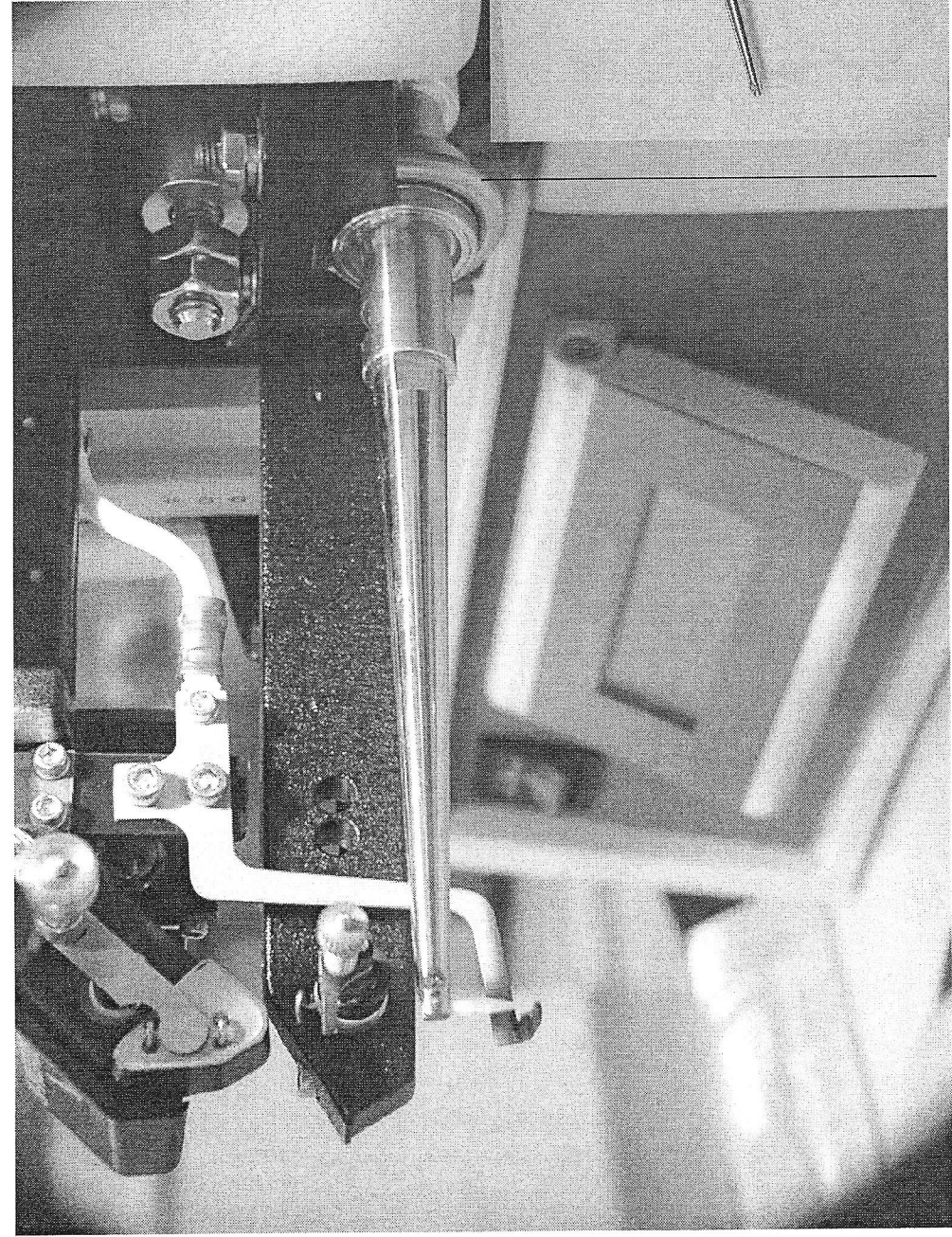

## Transducer Assembly

*With capillary for  
Thermosonic or  
Ultrasonic Ball  
Bonding*





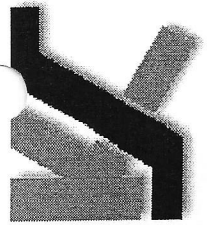

# Manual Ball Bonder Short Course

## Ball Bond (1st Bond) Formation

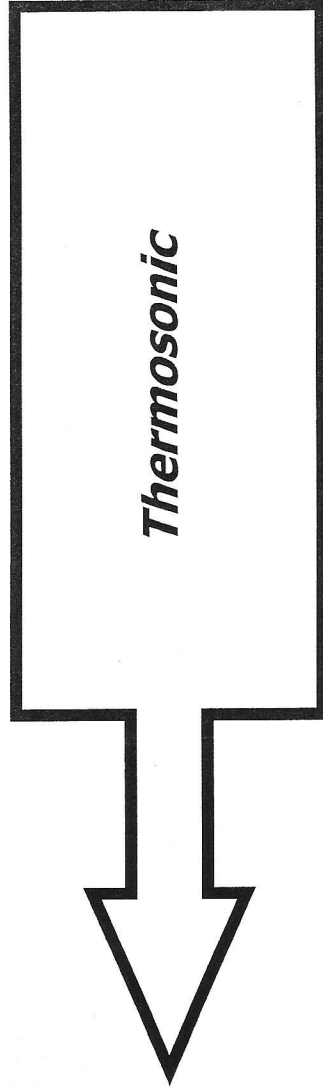
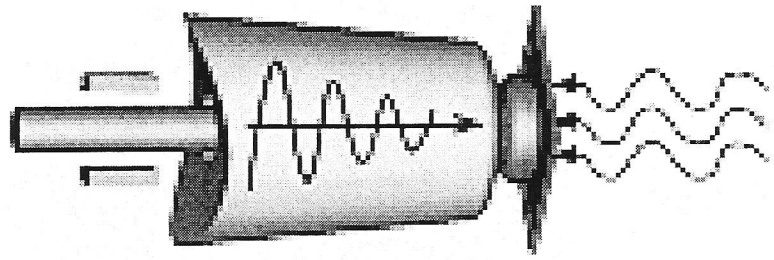

*Thermosonic*

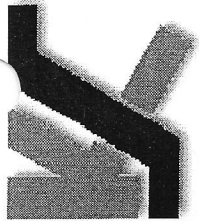

# **Manual Ball Bonder Short Course**

---

**Ball Bond  
(1st Bond)  
Formation**

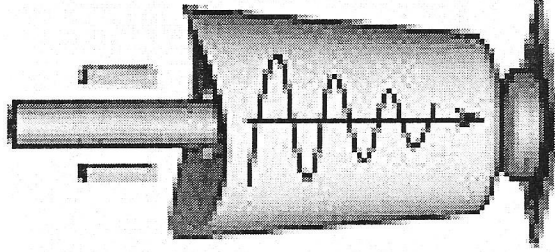
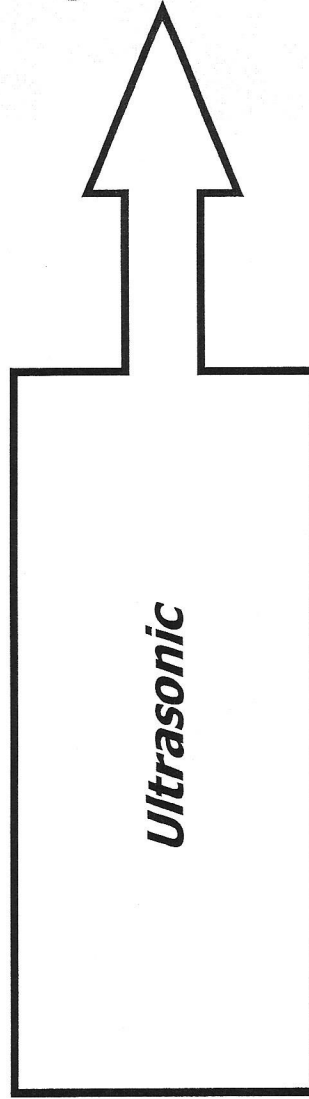

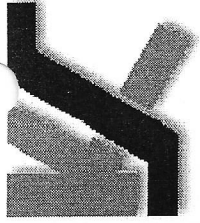

**Manual Ball Bonder Short Course**

---

**The 9 Stages**

**of a**

**Complete Bonding Cycle**



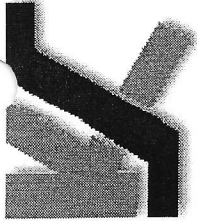

# Manual Ball Bonder Short Course

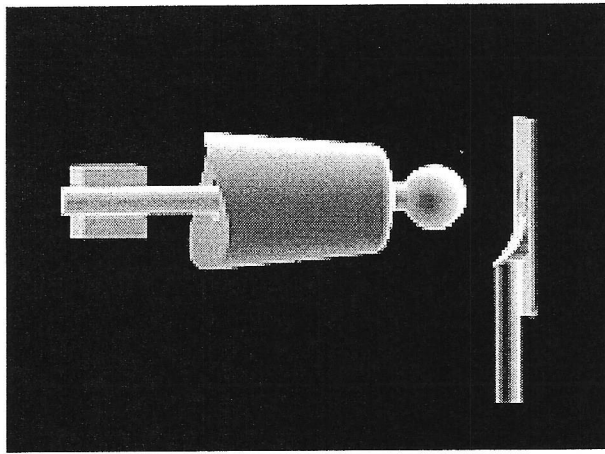

**Stage 1**

Free Air Ball  
Formation  
(clamps closed)

Free Air Ball  
is gripped in  
the capillary  
chamber  
(clamps open)

**Stage 2**

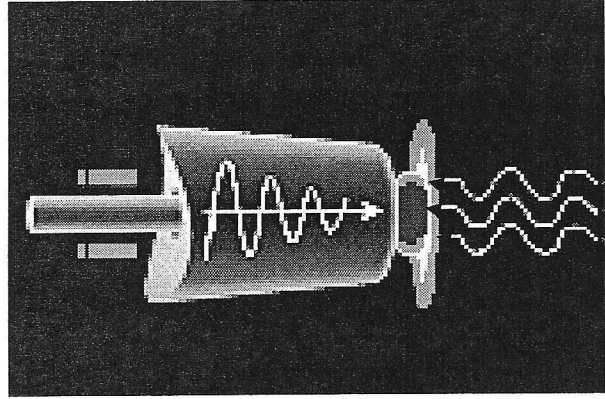
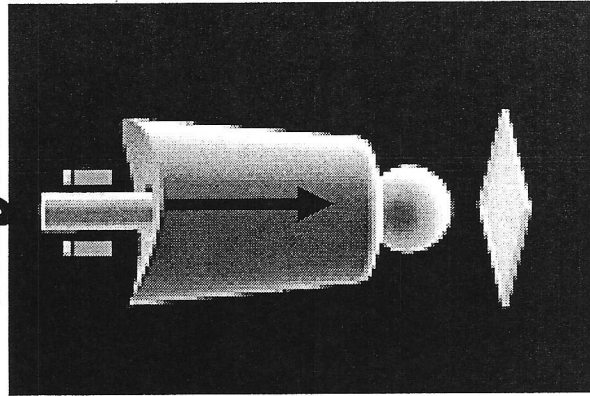

**Stage 3**

1st Bond Formation

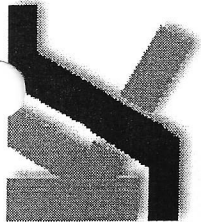

# Manual Ball Bonder Short Course

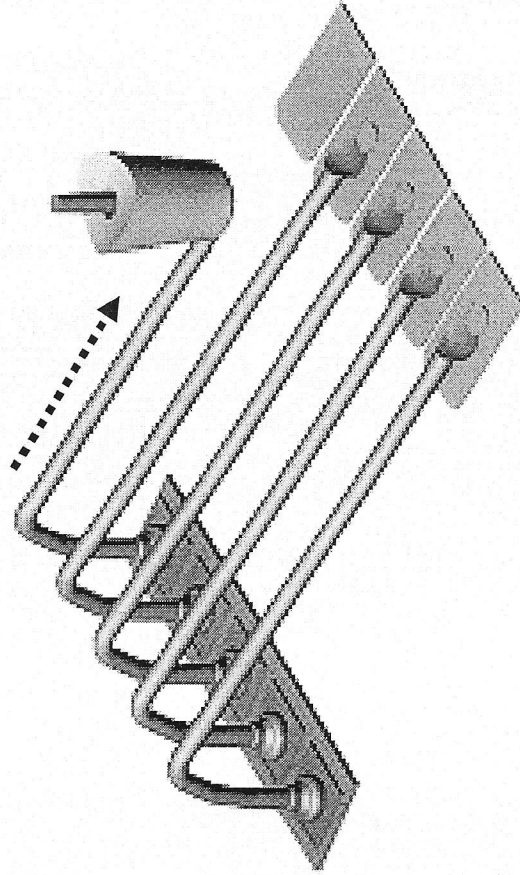
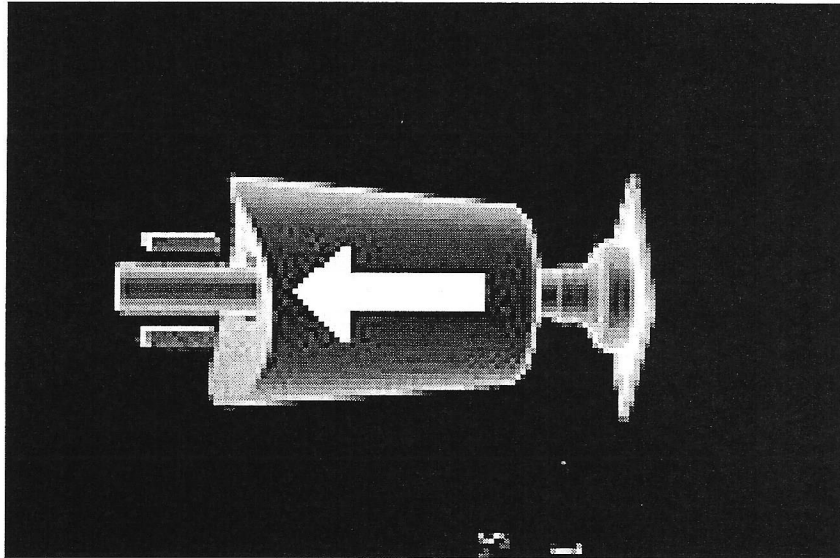

## Stage 5

*Capillary Rises to loop height position*

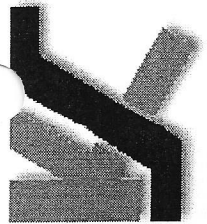

# Manual Ball Bonder Short Course

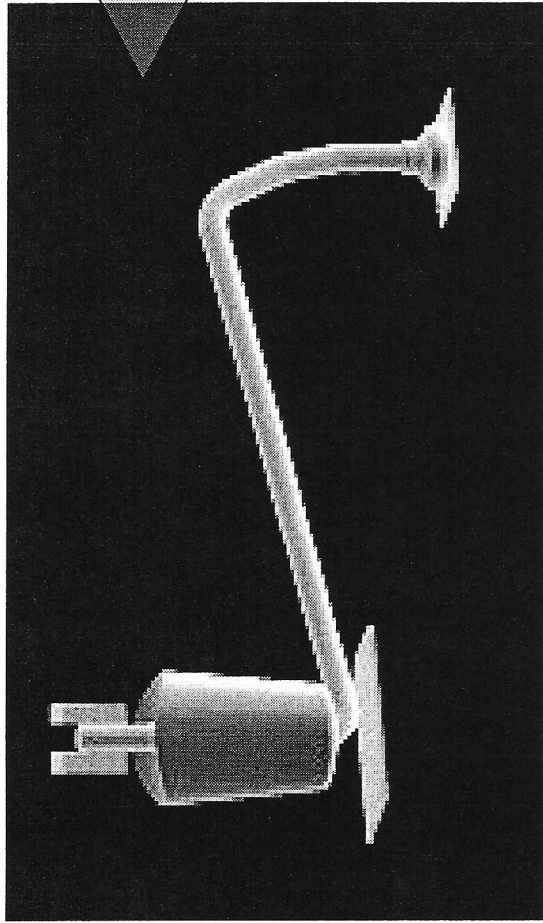

**Stage 6**

*Loop Formation*

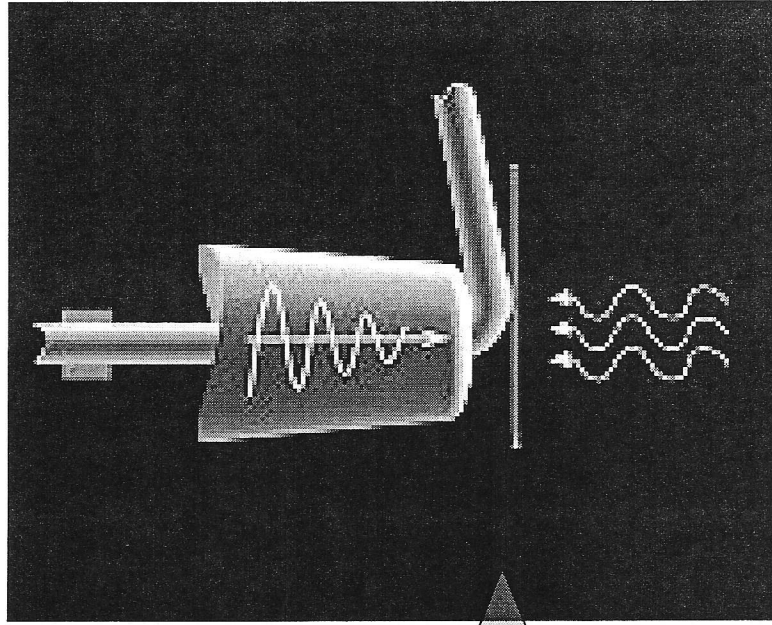

*Second Bond Formation*

**Stage 7**

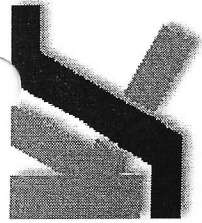

# Manual Ball Bonder Short Course

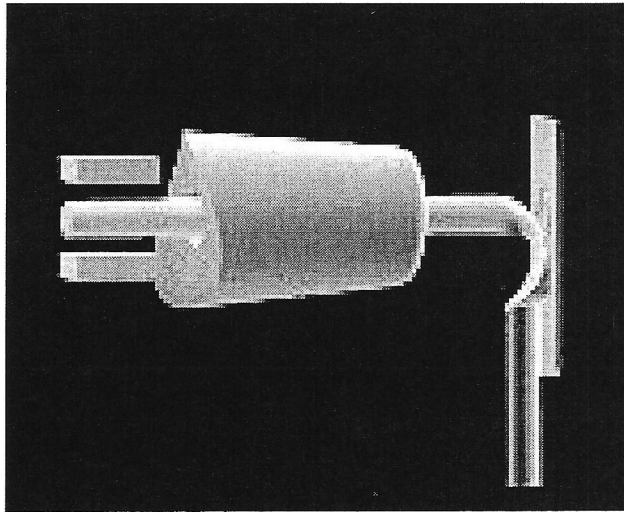

## Stage 8-1

*Creation of Tail Length  
(Tail Pole)*

*Disconnection  
of the Tail  
(Tail Break)*

## Stage 8-2

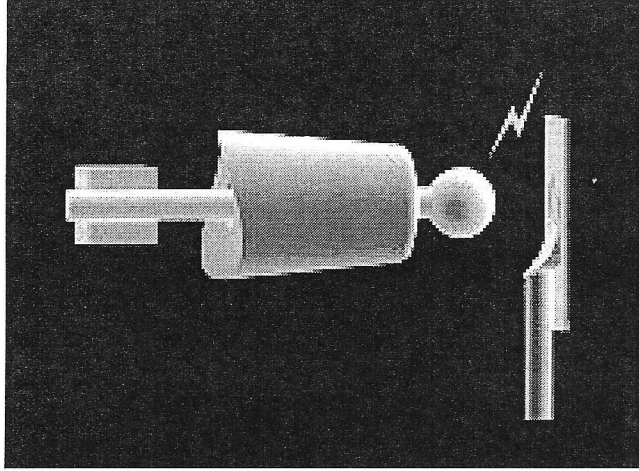
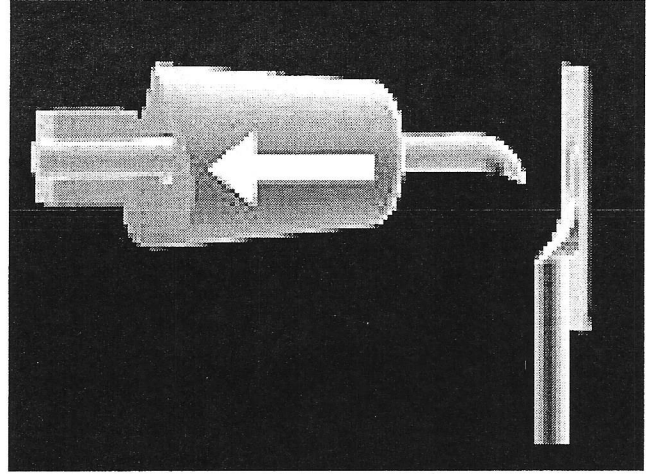

## Stage 9

*Formation of a New FAB*

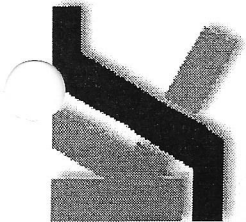

# **Manual Ball Bonder Short Course**

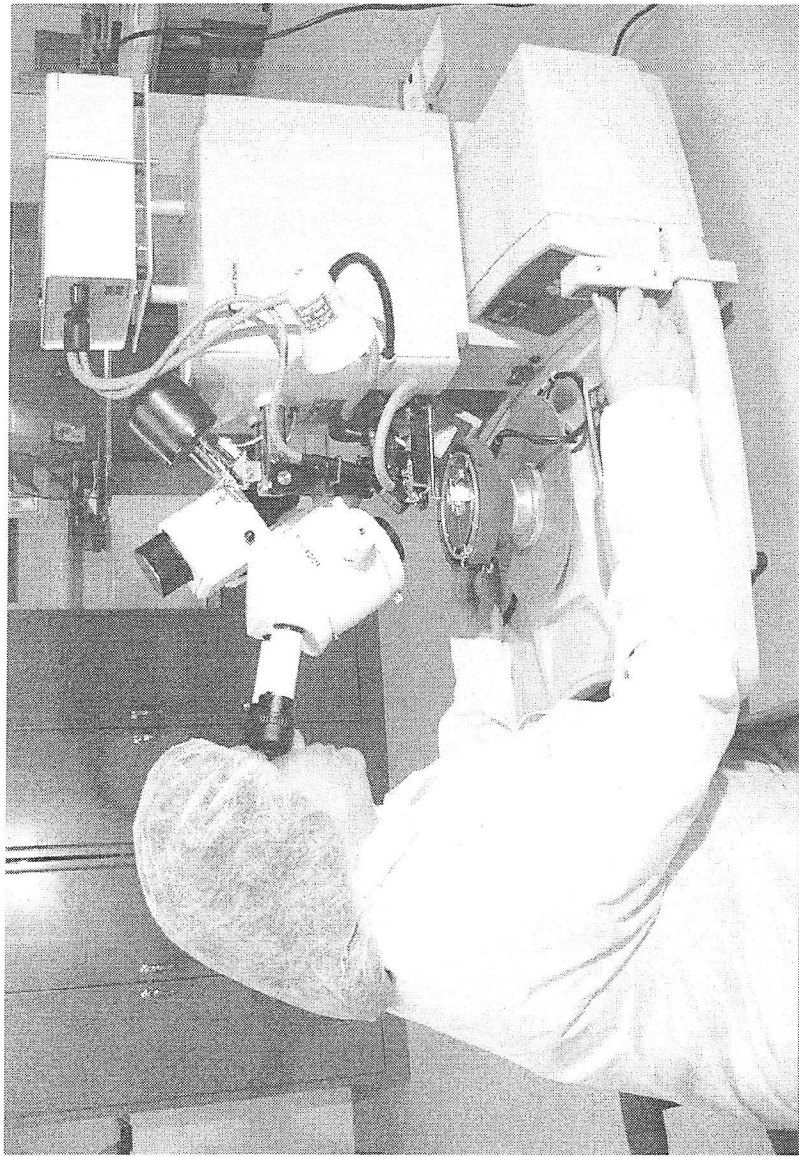

## **Manual Machine Operation**

*Operator maintains precise control of a Manual Machine*



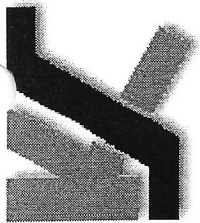

# Manual Ball Bonder Short Course

## Ball bonding Cycle in Semi/Automatic Mode

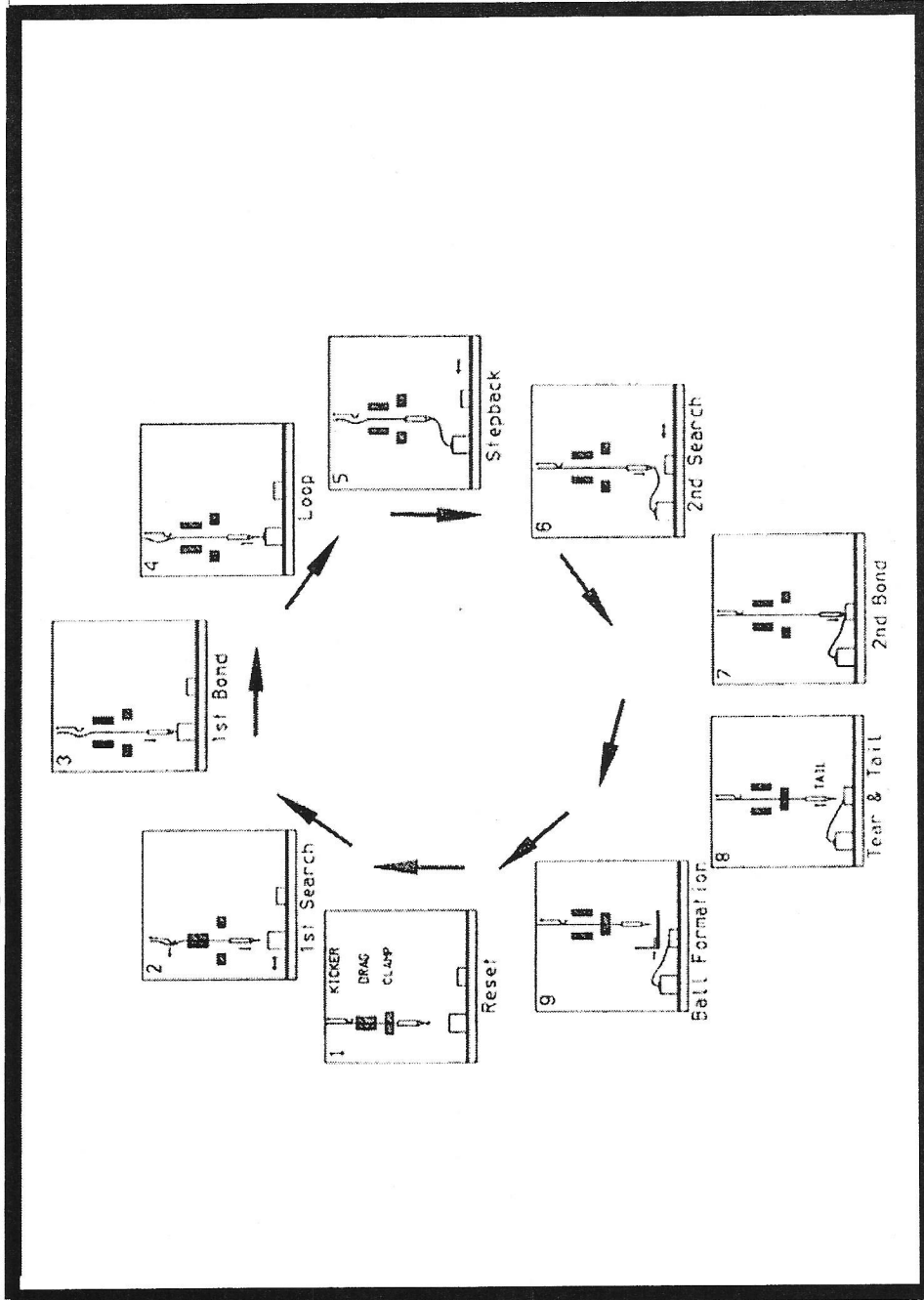

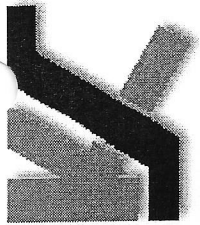

# Manual Ball Bonder Short Course

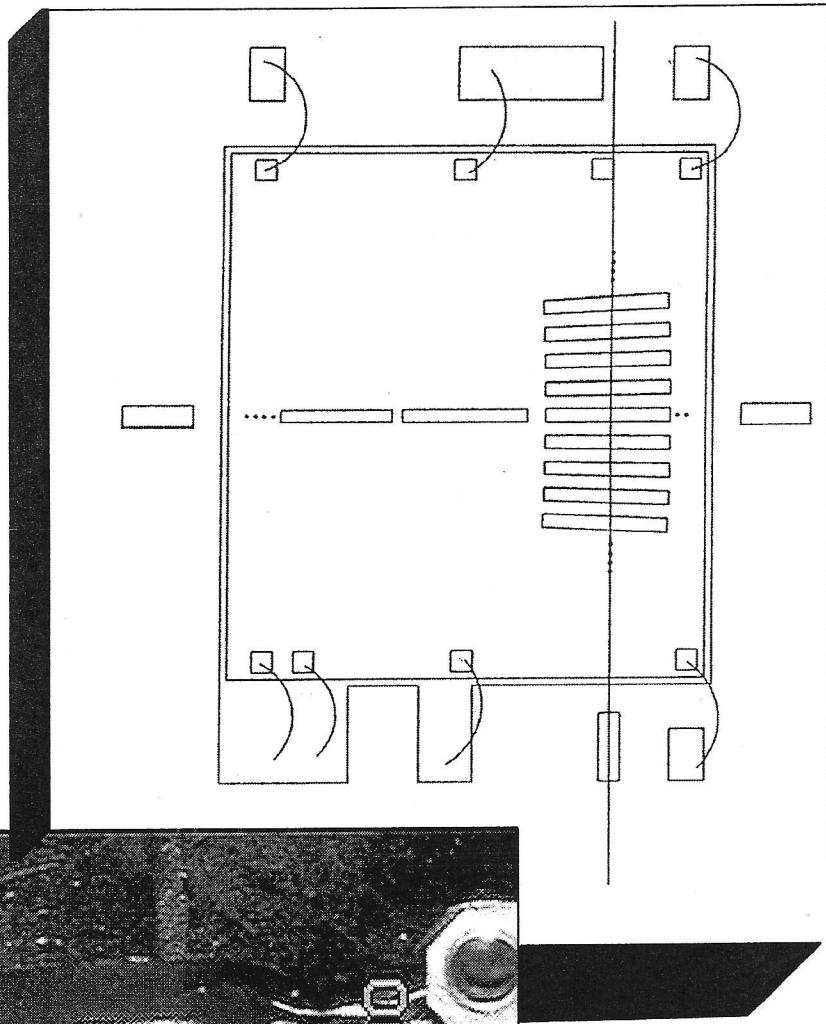
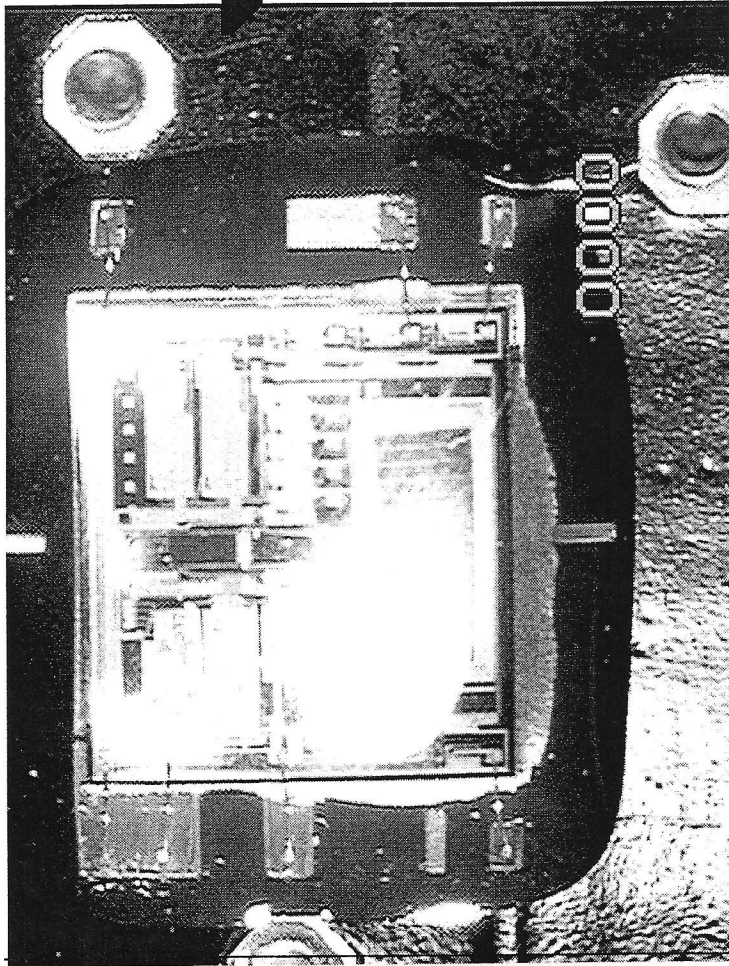

*Typical Wire Bond Diagram*

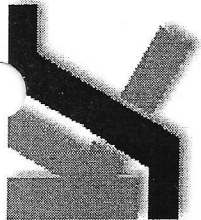

# **Manual Ball Bonder Short Course**

---

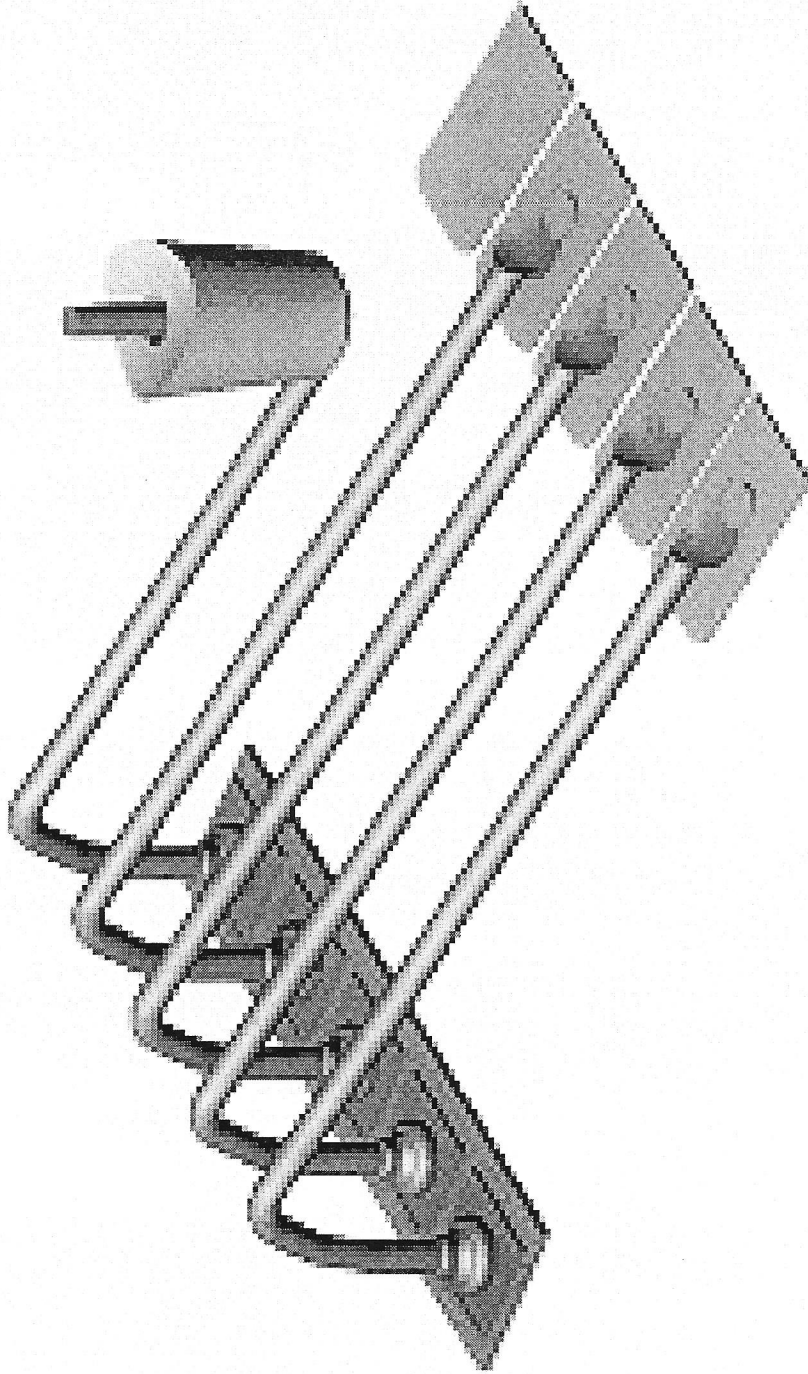

*A Step in Loop Formation during Ball Bonding*



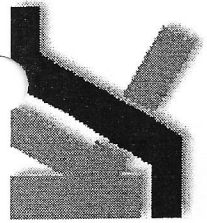

# **Manual Ball Bonder Short Course**



## **Second Bond Shape**

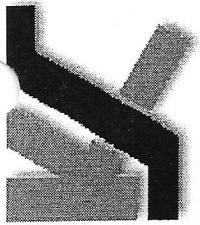

# **Manual Ball Bonder Short Course**

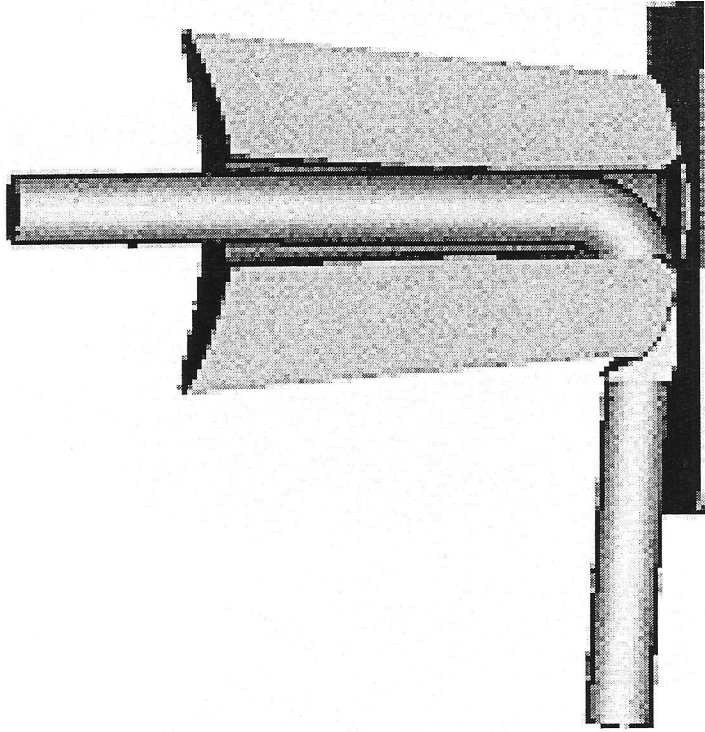

***Tail bond Area is very small***

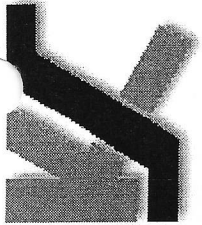

# Manual Ball Bonder Short Course

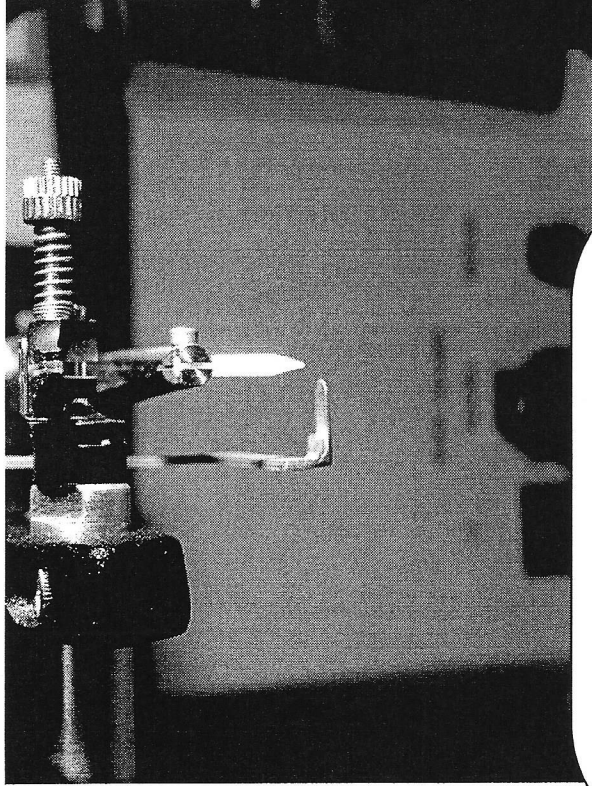

*Nefo at Rest*

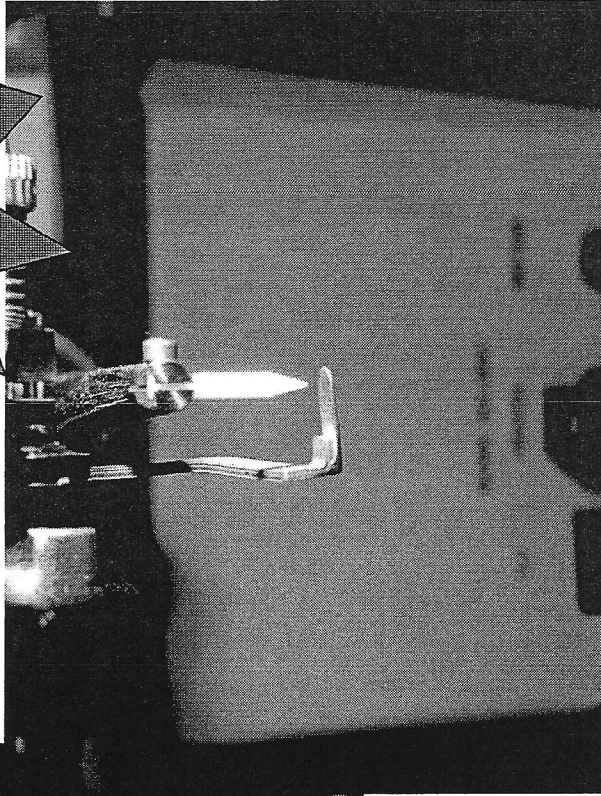

*Nefo at Fire Position*

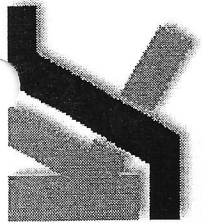

# Manual Ball Bonder Short Course

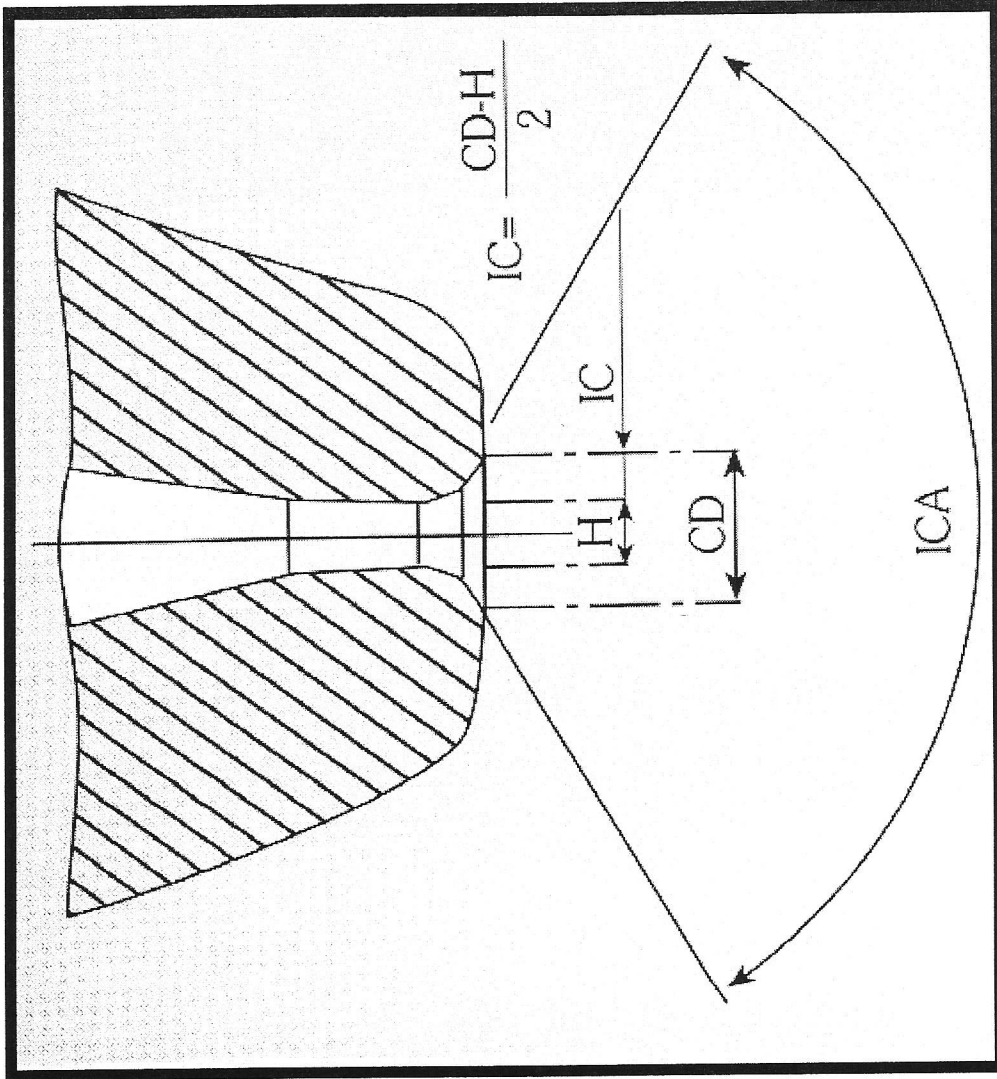

*Typical Capillary Tip Dimensions*

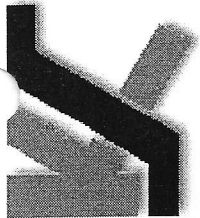

# Manual Ball Bonder Short Course

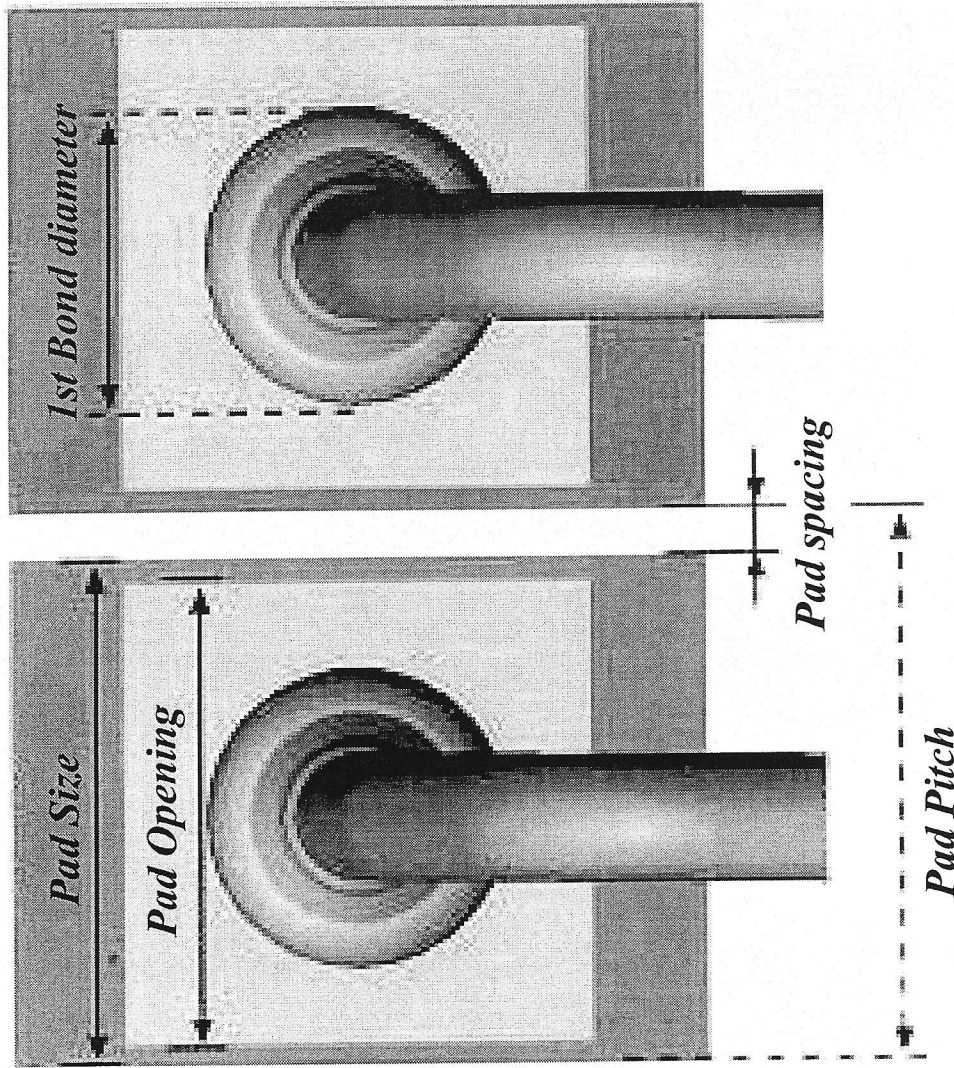

**Pad Opening vs. 1st Bond Diameter**





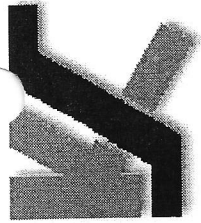

# Manual Ball Bonder Short Course

## Capillary Dimensions

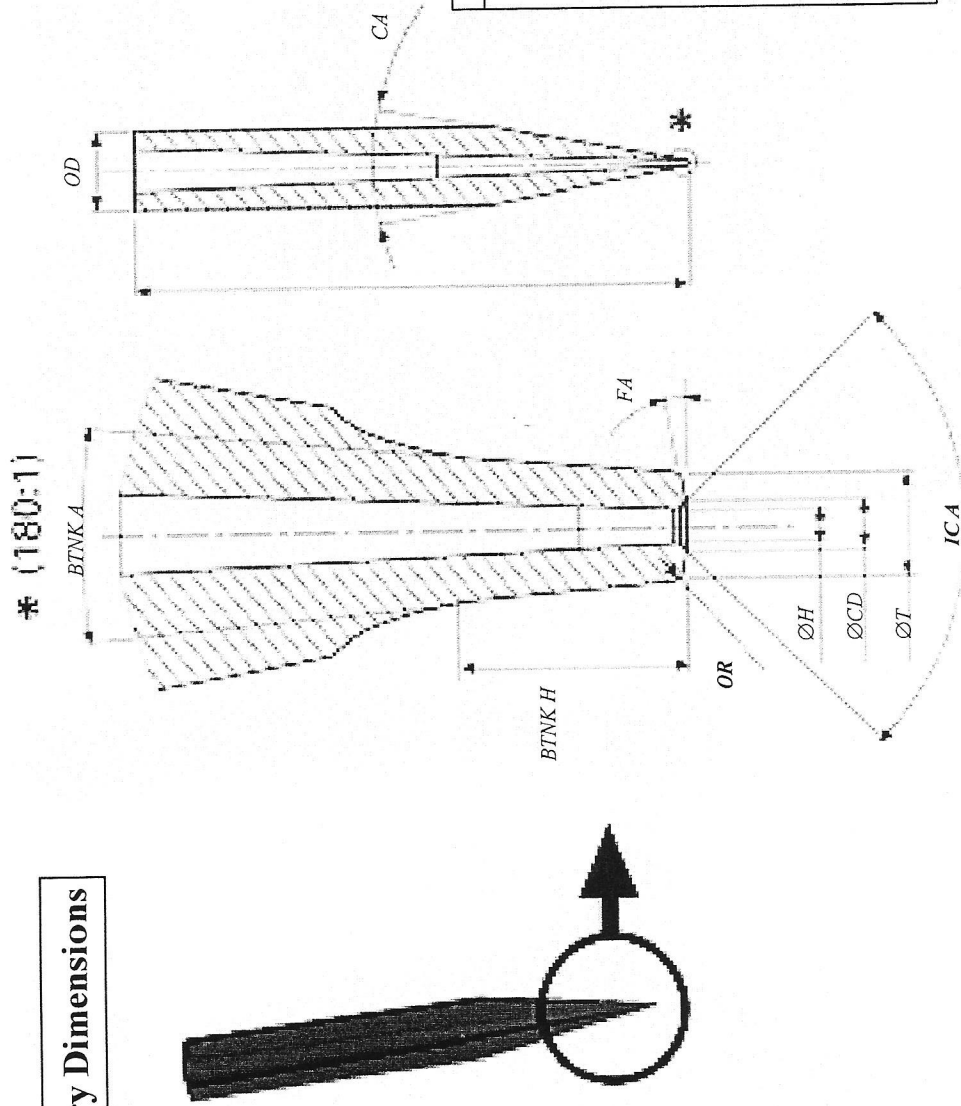

Capillary Parameters:	
FA	- Face Angle
OR	- Outer Radius
H	- Hole Diameter
CD	- Chamfer Diameter
T	- Tip Diameter
ICA	- Inner Chamfer Angle
OD	- Outer Diameter
CA	- Cone Angle
L	- Length
BTNK H	- Bottleneck Height
BTNK A	- Bottleneck Angle

## Capillary Detailed Dimensions

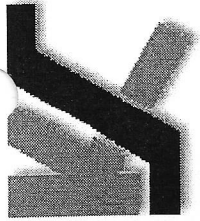

# **Manual Ball Bonder Short Course**

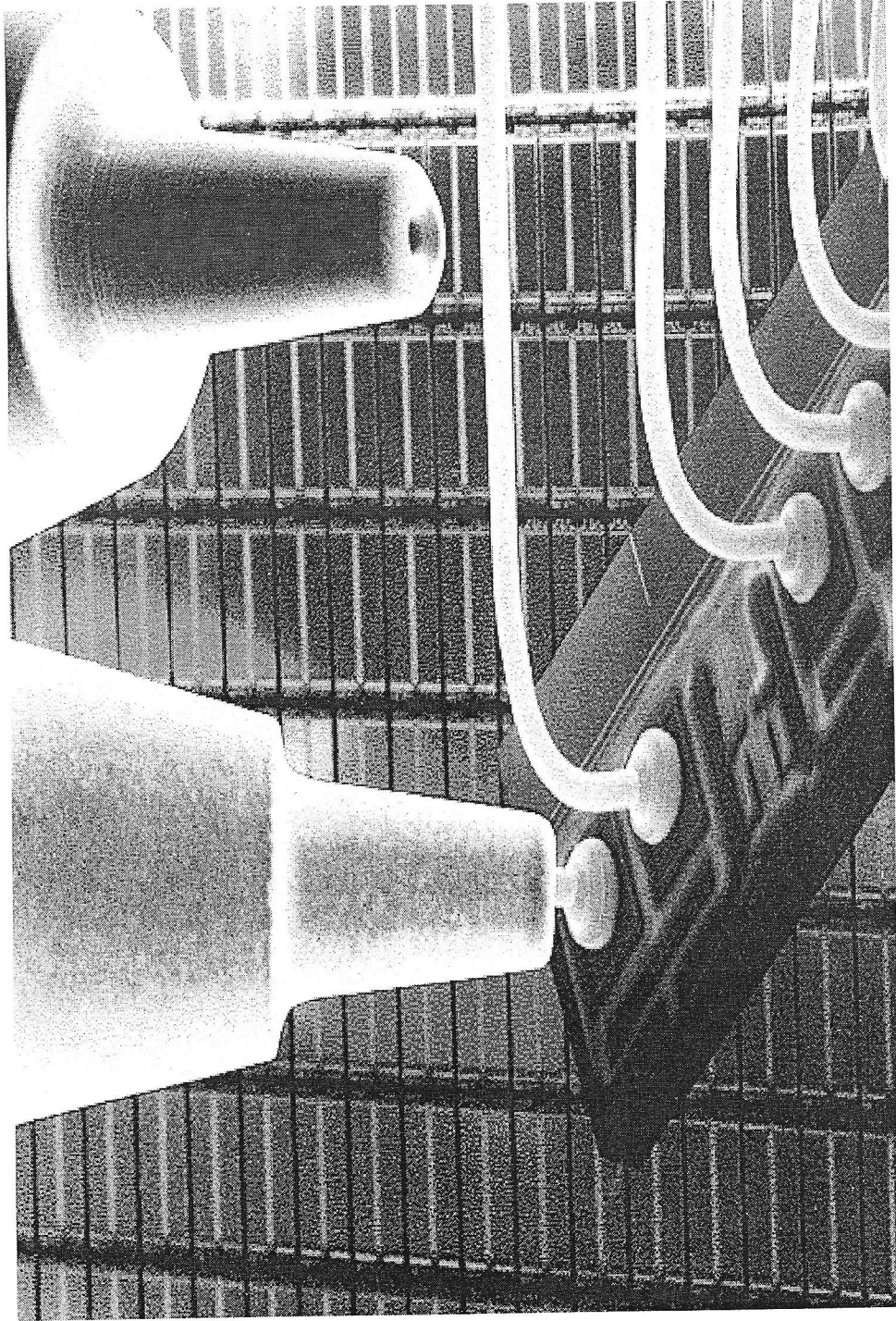

***Capillary on Close Center Bonds***

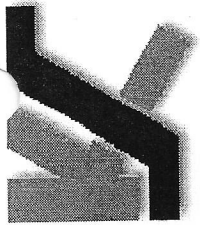

# *Manual Ball Bonder Short Course*

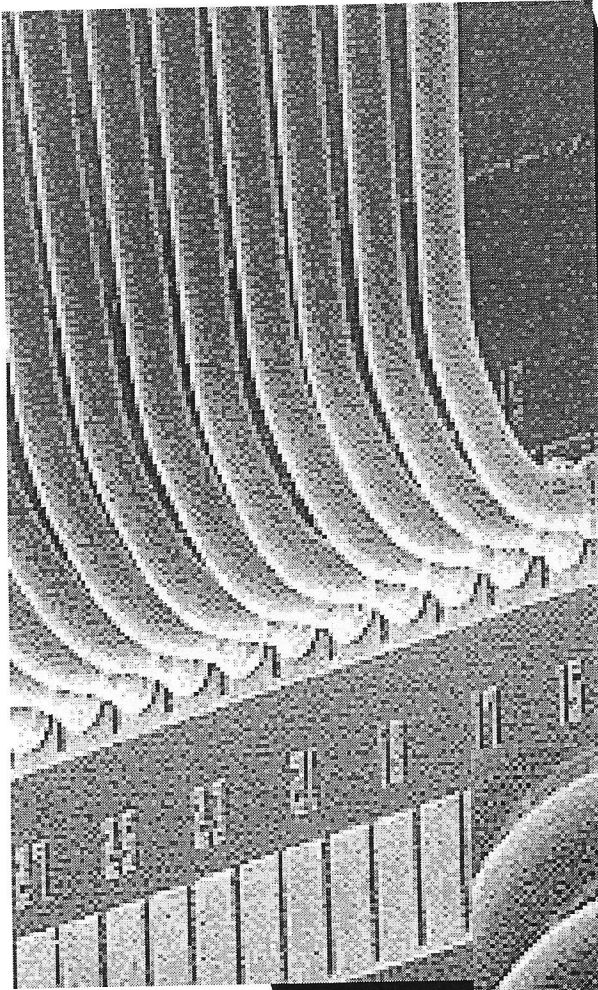

*Close Center Bonds*

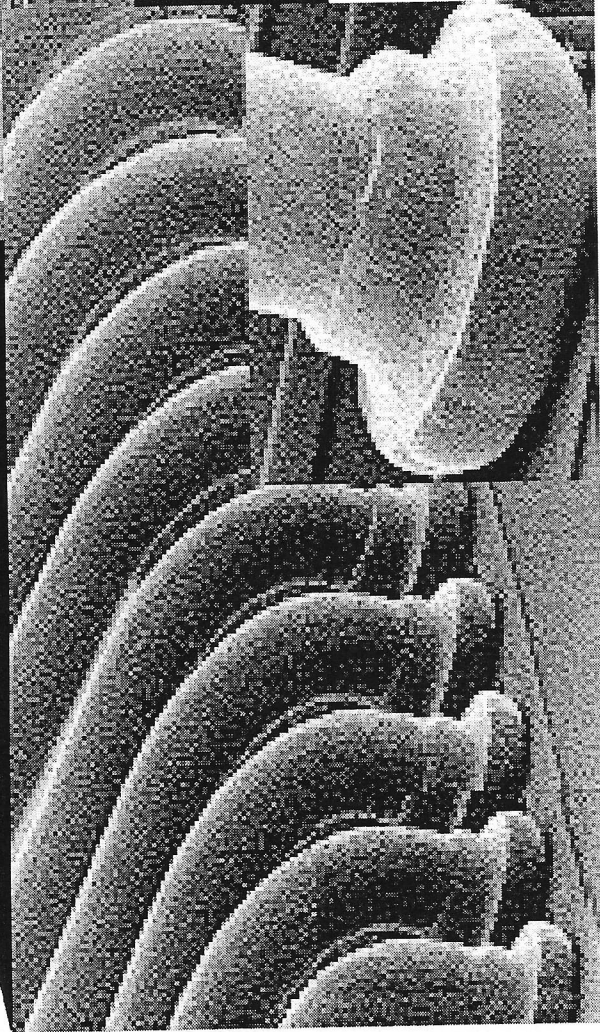

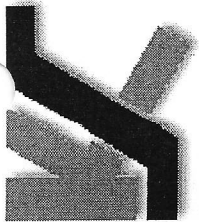

# Manual Ball Bonder Short Course

## Capillary Dimensions

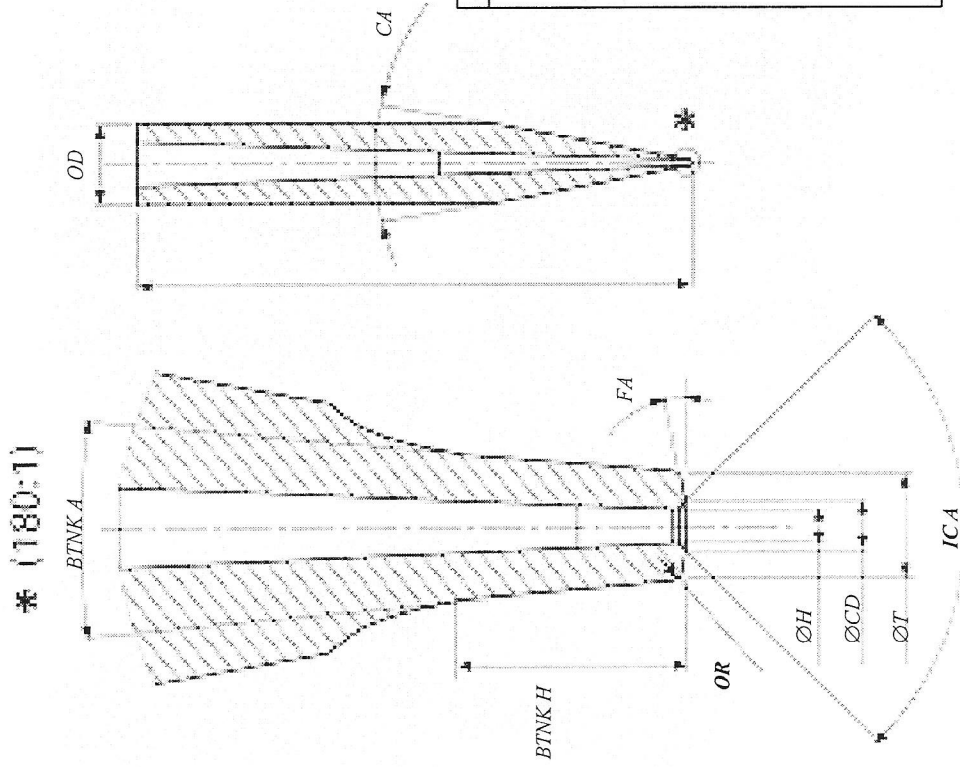
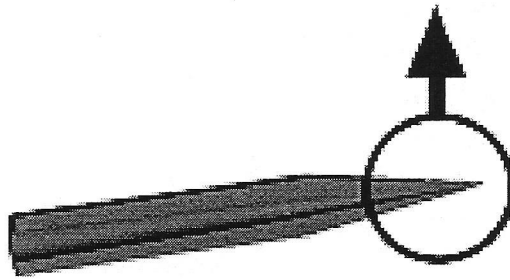

Capillary Parameters:	
FA	- Face Angle
OR	- Outer Radius
H	- Hole Diameter
CD	- Chamfer Diameter
T	- Tip Diameter
ICA	- Inner Chamfer Angle
OD	- Outer Diameter
CA	- Cone Angle
L	- Length
BTNK H	- Bottleneck Height
BTNK A	- Bottleneck Angle

## Capillary Detailed Dimensions

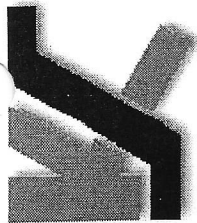

# Manual Ball Bonder Short Course

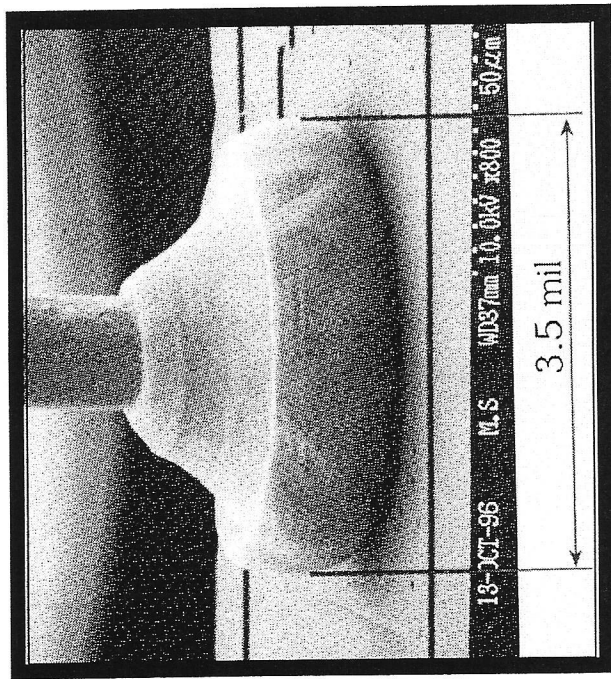

*A bond formed by 90° chamfer*

*A bond formed by 120° chamfer*

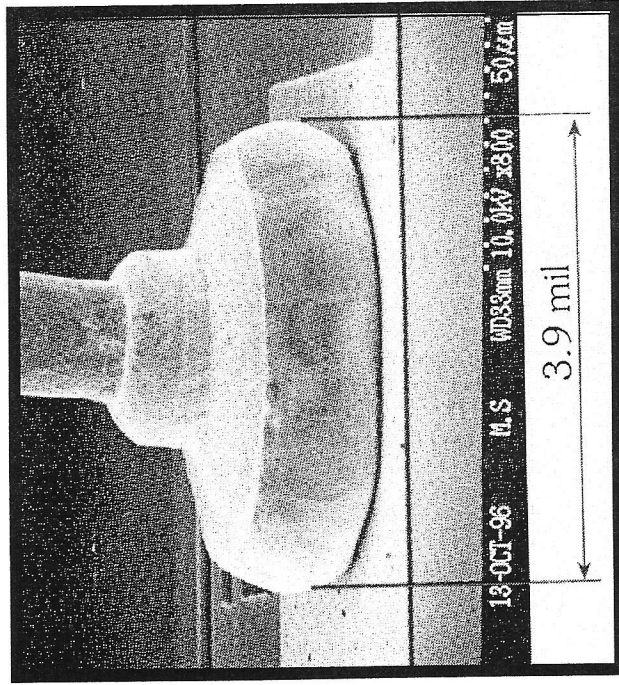

## Examples of Bonded Balls

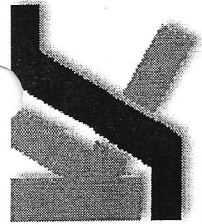

# Manual Ball Bonder Short Course

## K&S Capillary Design Recommendations

Wire Diameter (mil)	Recommended Hole (mil)	Minimum Hole (mil)
2.00	3.00	2.40
1.50	2.20	1.80
1.30	1.80	1.50
1.20	1.70	1.40
1.10	1.60	1.30
1.00	1.50	1.20
0.90	1.20	1.10
0.80	1.00	0.95
0.70	0.90	0.85

## Capillary Hole Size vs. Wire Diameter

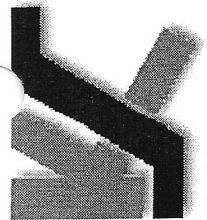

# Manual Ball Bonder Short Course

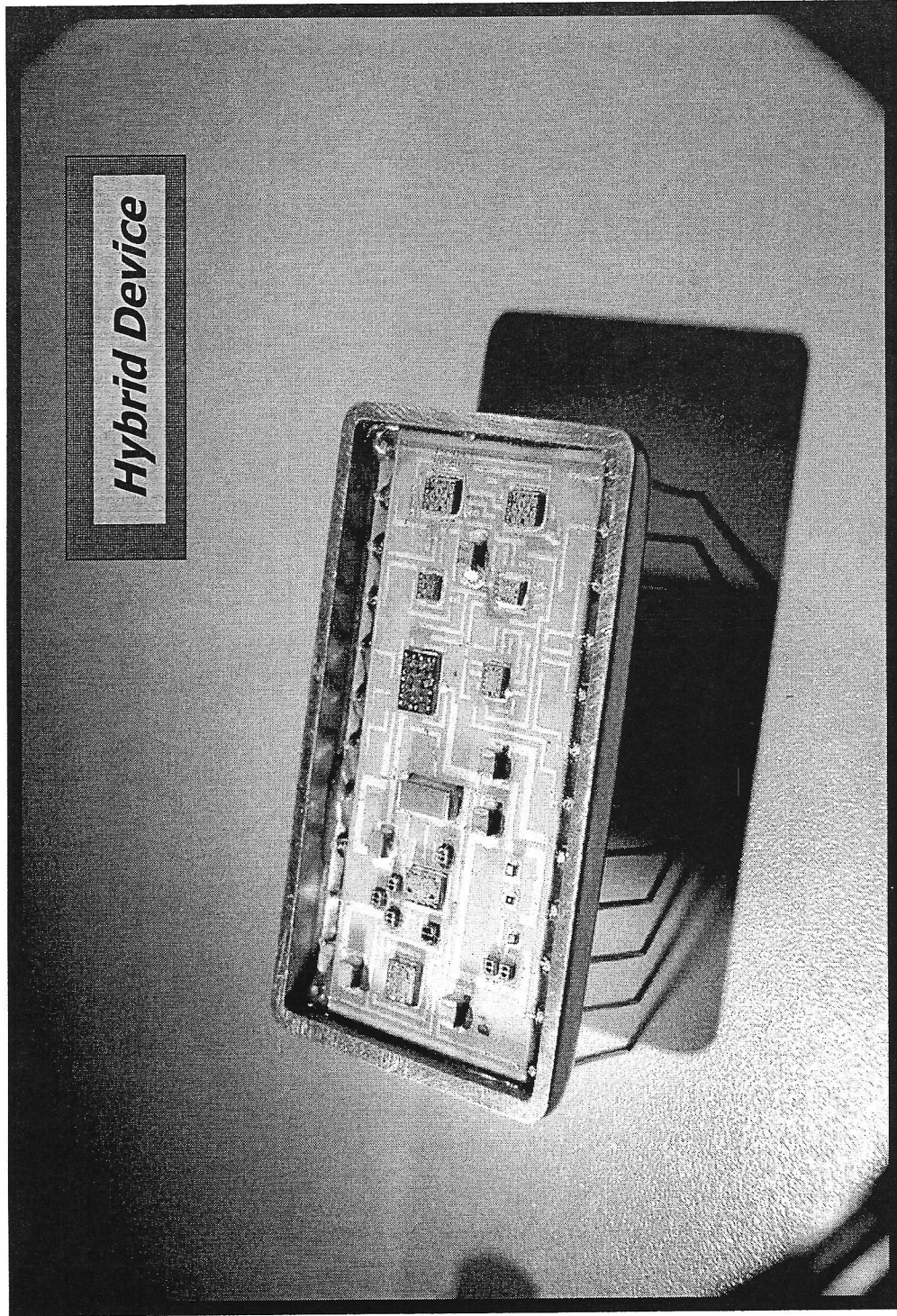

*Hybrid Device*

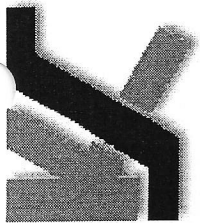

# Manual Ball Bonder Short Course

## Looping

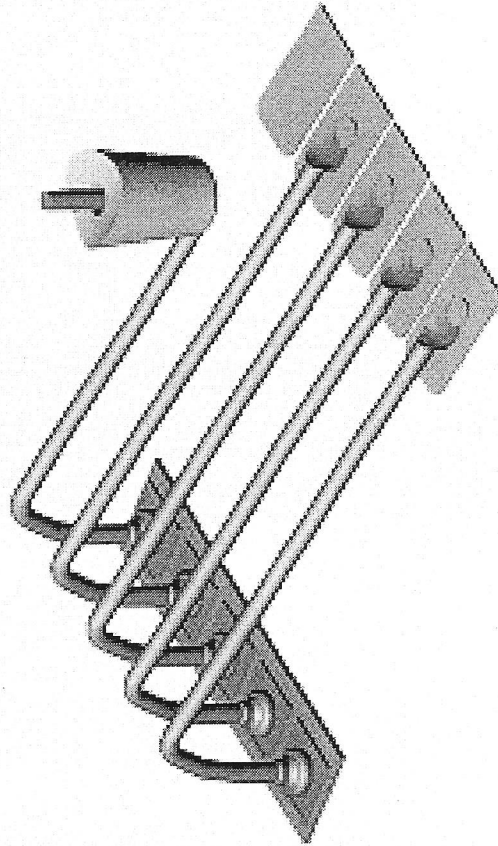
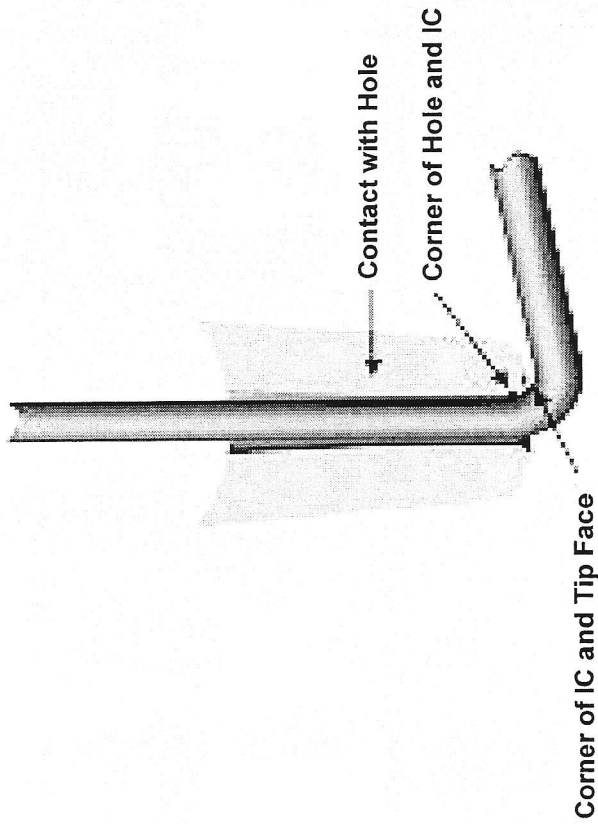

## Engineering Considerations



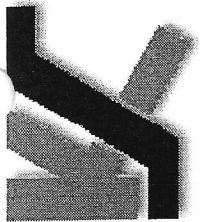

# Manual Ball Bonder Short Course

**Capillary Hole Size is  
Critical**

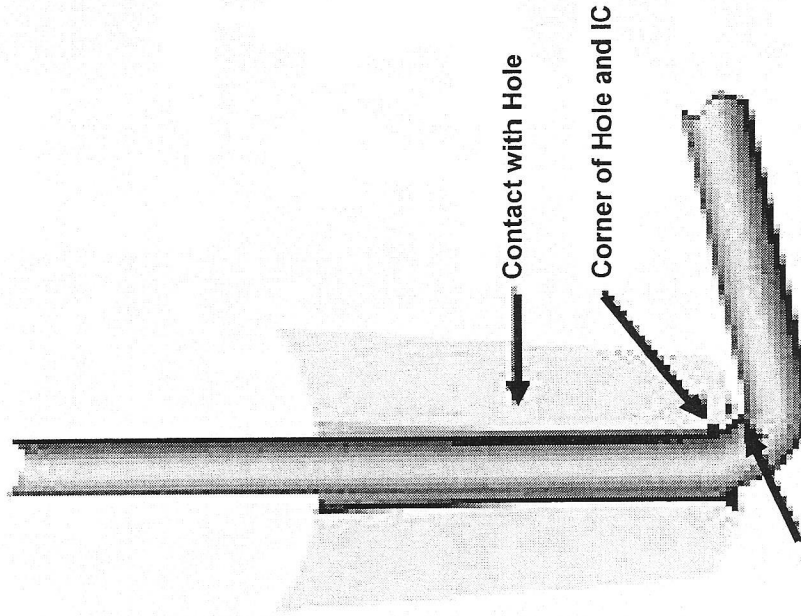

Corner of IC and Tip Face



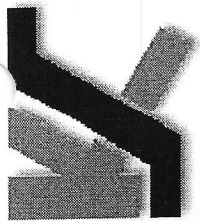

# Manual Ball Bonder Short Course

## Capillary Dimensions

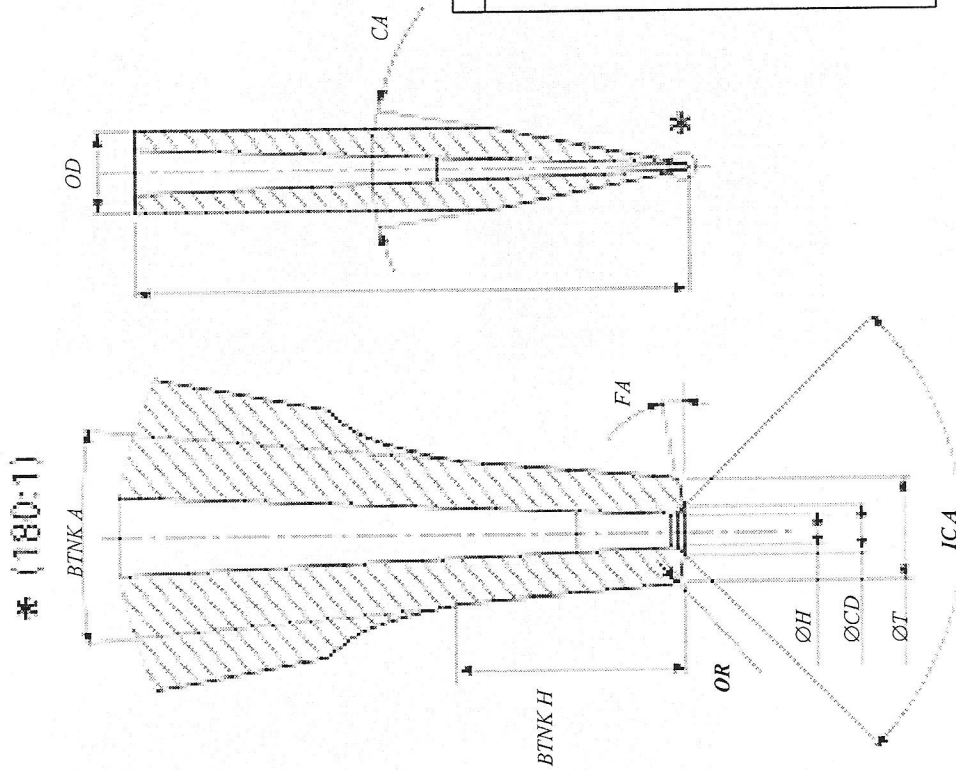
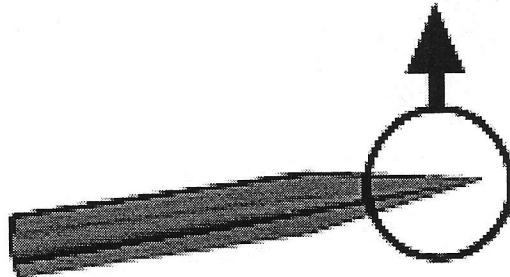

Capillary Parameters:	
FA	- Face Angle
OR	- Outer Radius
H	- Hole Diameter
CD	- Chamfer Diameter
T	- Tip Diameter
ICA	- Inner Chamfer Angle
OD	- Outer Diameter
CA	- Cone Angle
L	- Length
BTNK H	- Bottleneck Height
BTNK A	- Bottleneck Angle

## Capillary Detailed Dimensions

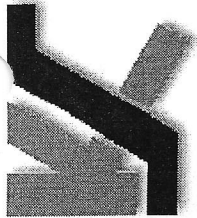

# **Manual Ball Bonder Short Course**

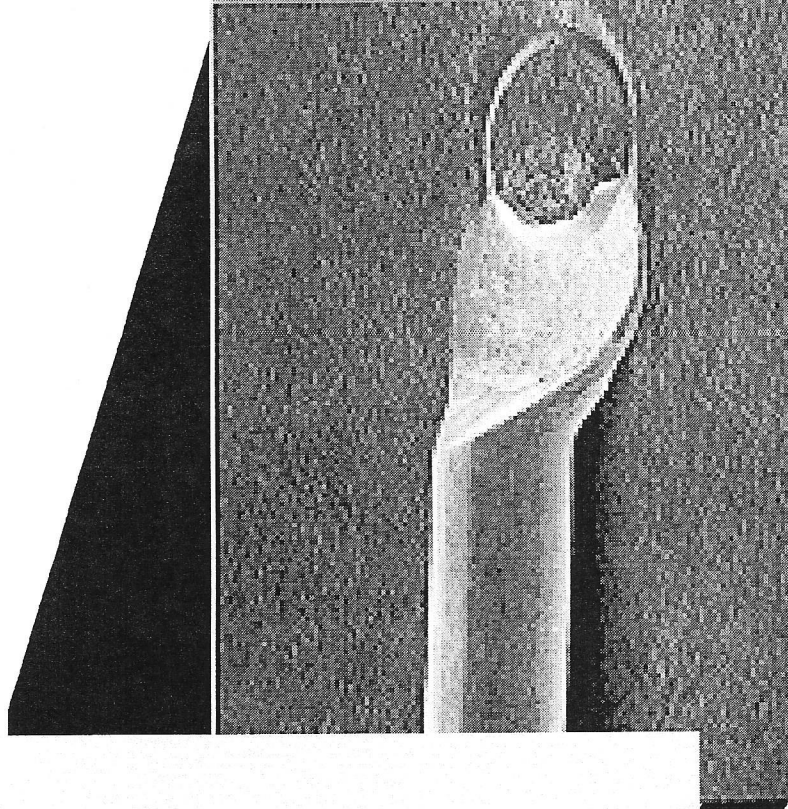
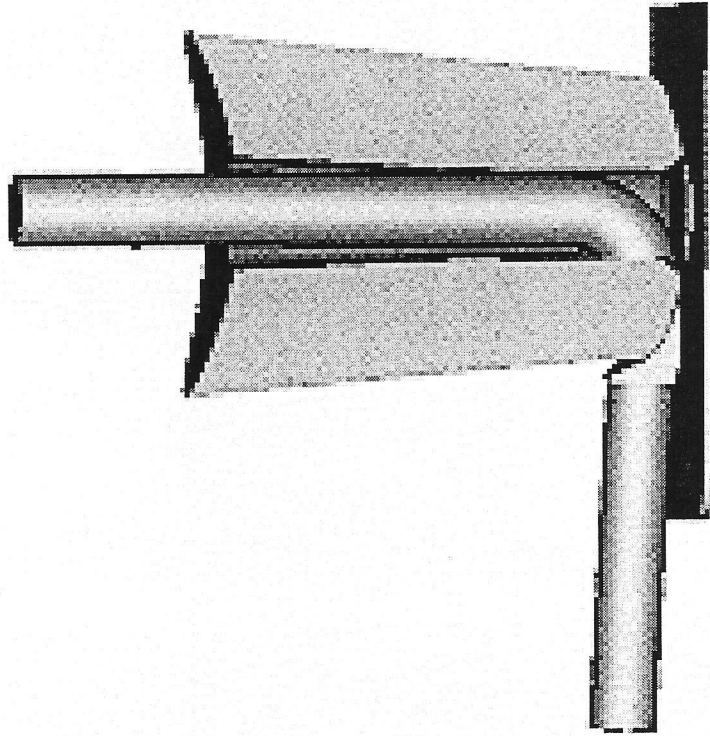

***The Capillary controls 2nd Bond Shape and Strength***

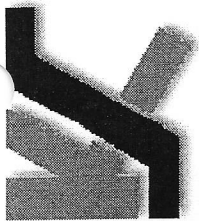

# Manual Ball Bonder Short Course

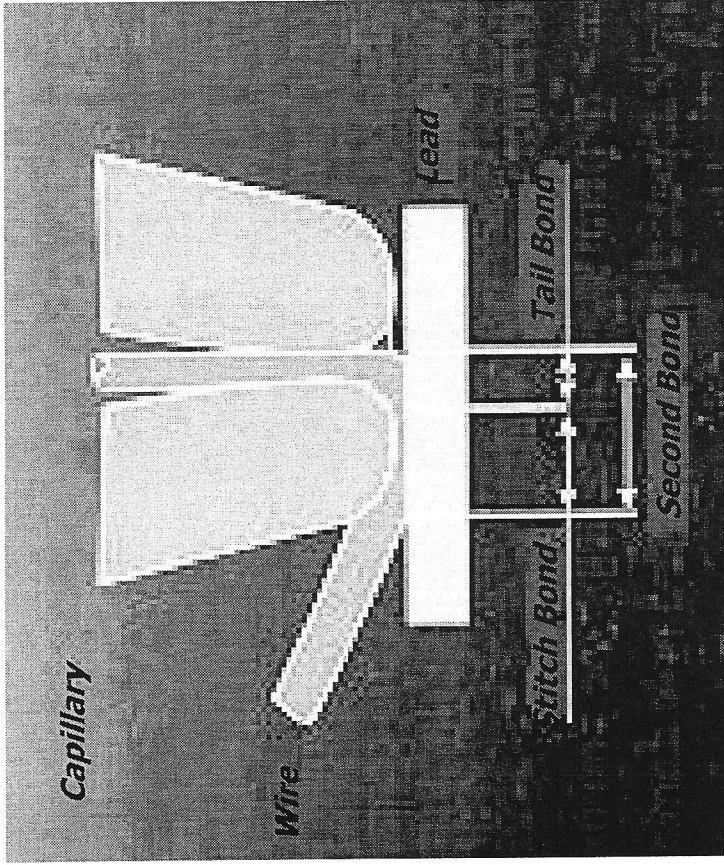
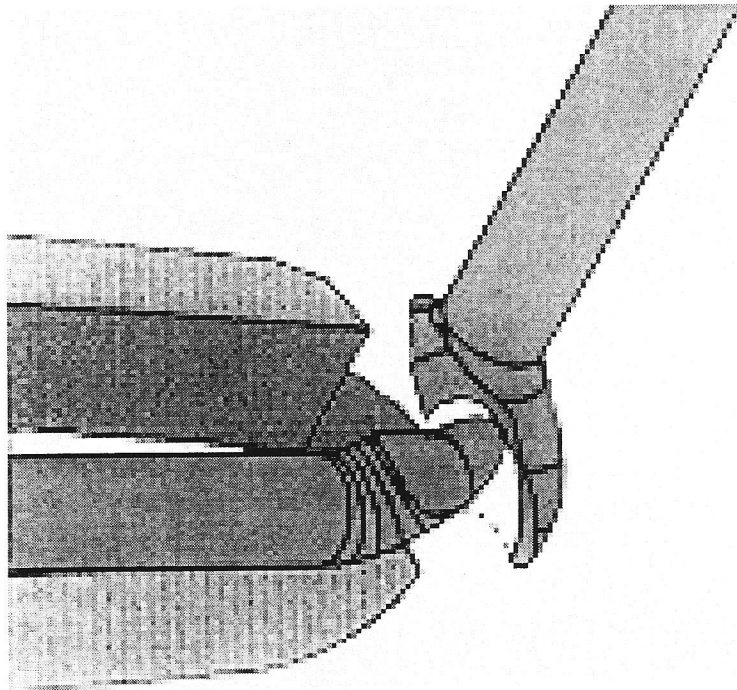

**Capillary makes 2nd Bond  
and Tail Bond Simultaneously**

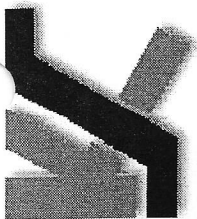

# Manual Ball Bonder Short Course

## Capillary Effective Face Cross Section

4 vs. 7 mil tip, 8 vs. 15 degree face angle

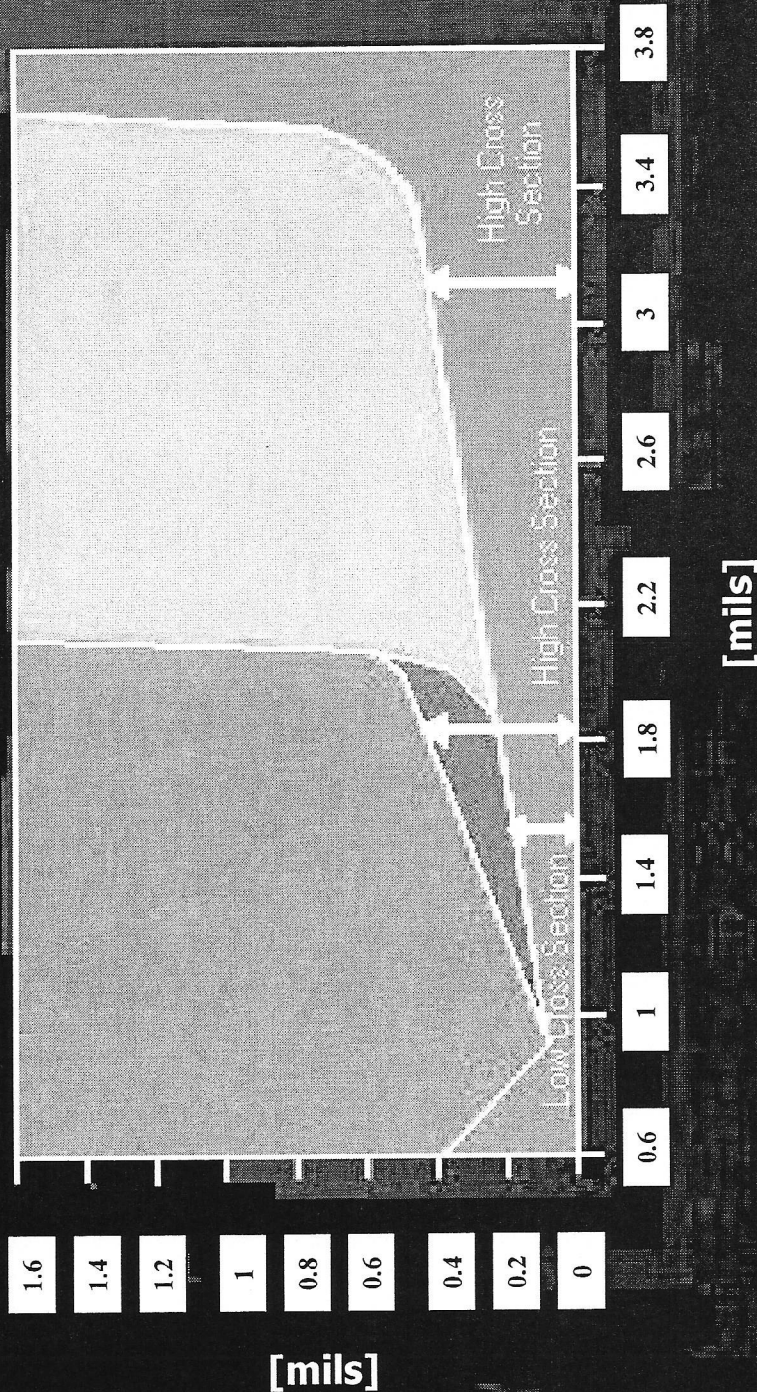

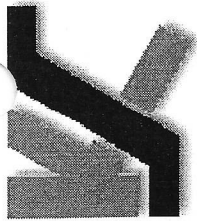

# Manual Ball Bonder Short Course

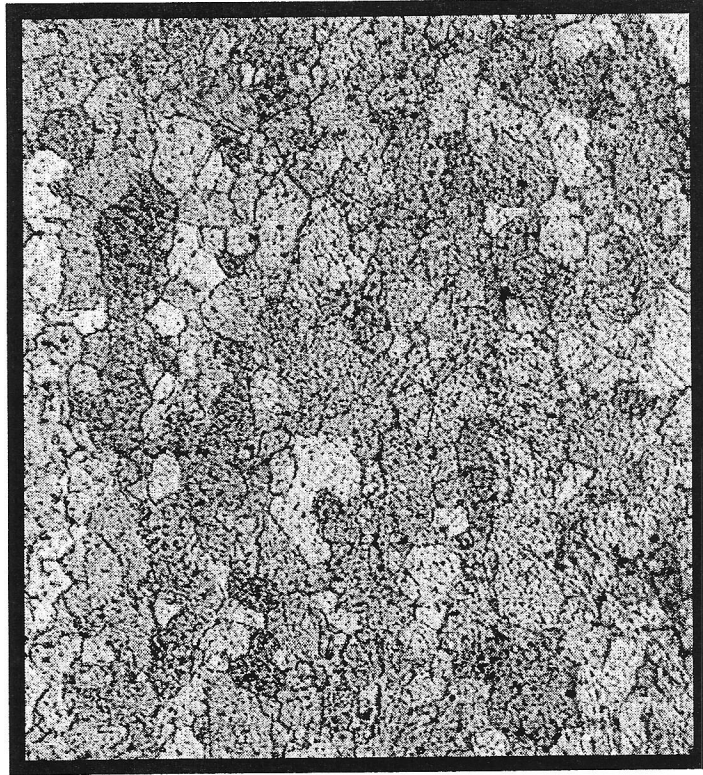

Typical Gold Grain -  
Cross Section of  
Wire

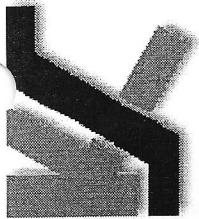

# **Manual Ball Bonder Short Course**

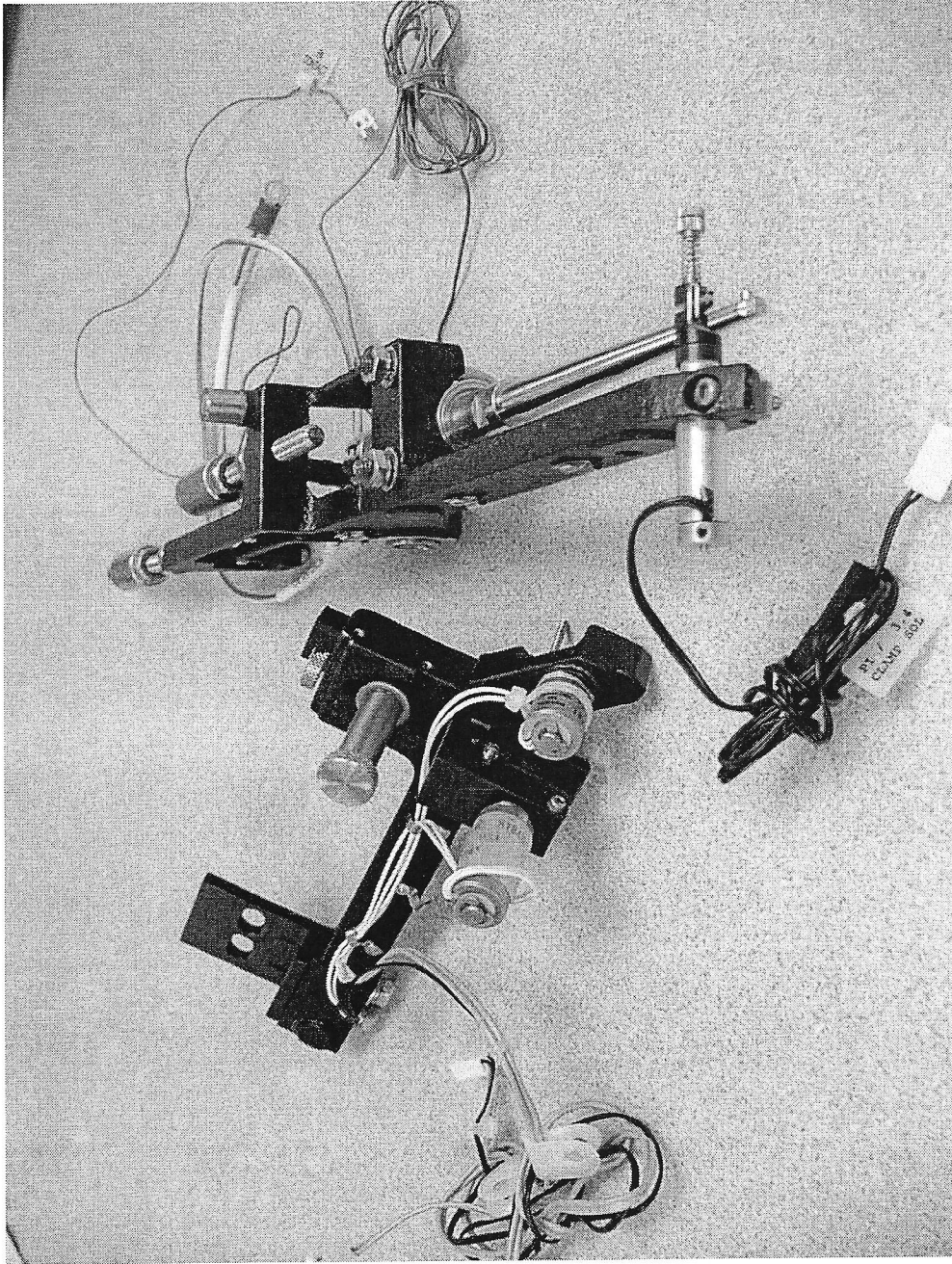

***Bondhead Components for the Manual Ball Bonder***

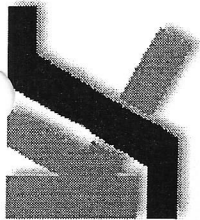

# **Manual Ball Bonder Short Course**

---

**Tail for  
Ball  
Formation**

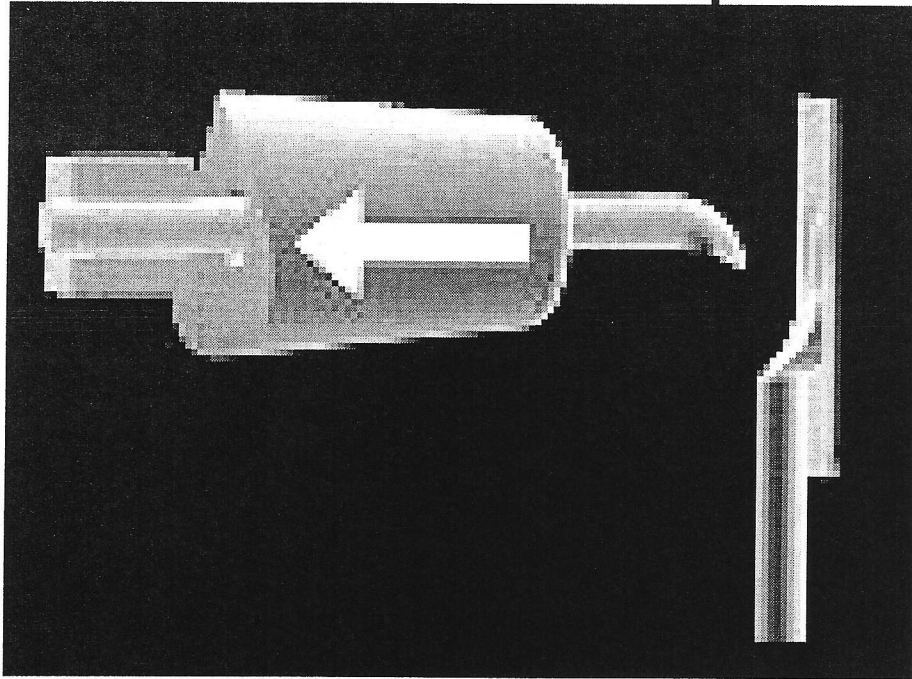

**Tail must be available for Ball Formation**



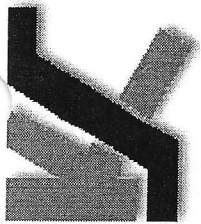

# **Manual Ball Bonder Short Course**

---

**"Free Air"  
Ball Formation**

**Note: Clamps are  
Closed**

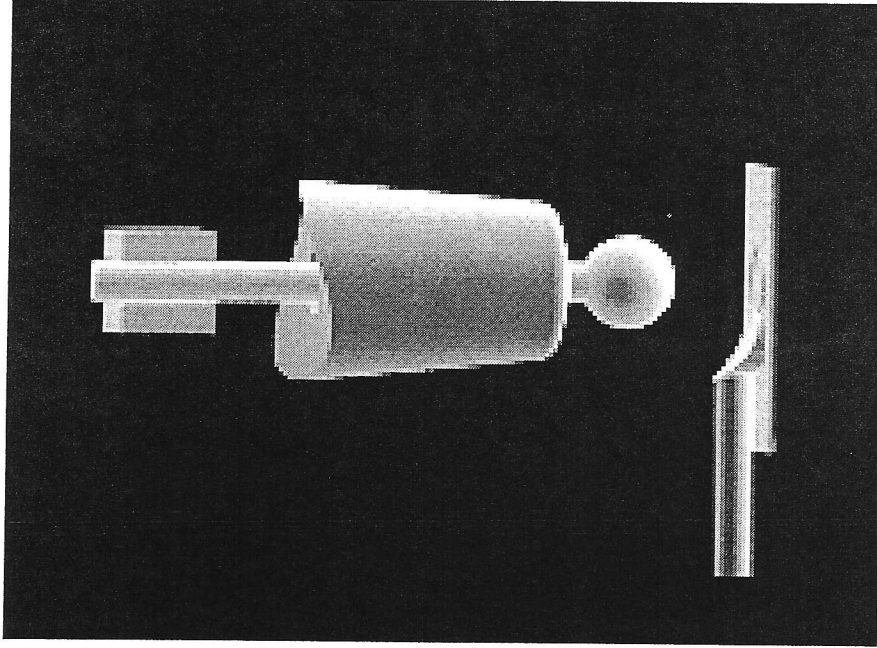

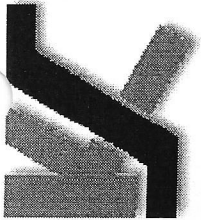

# ***Manual Ball Bonder Short Course***

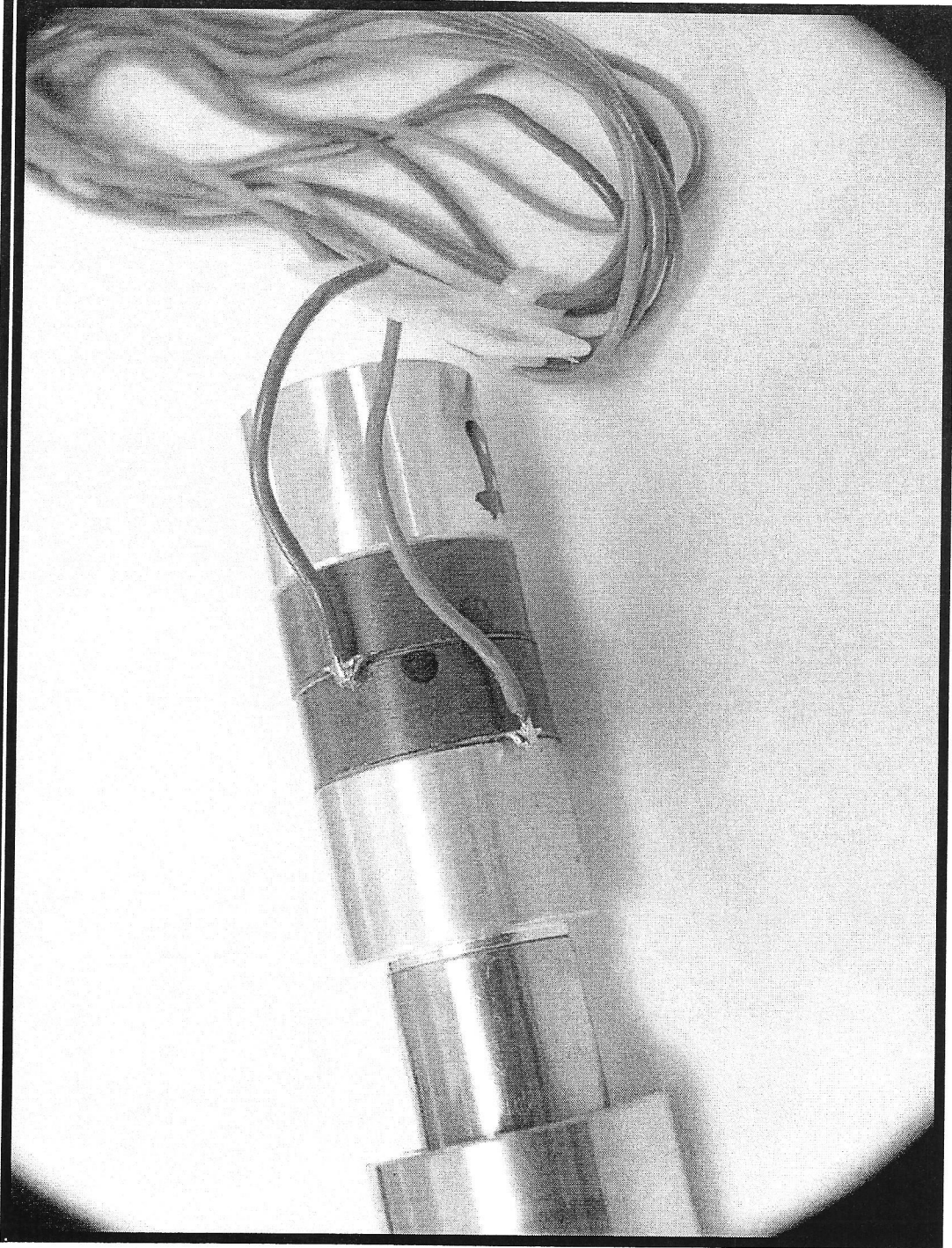

***Transducer Crystals with Wiring***

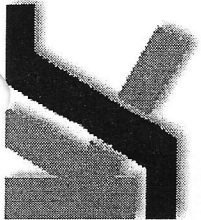

# **Manual Ball Bonder Short Course**

---

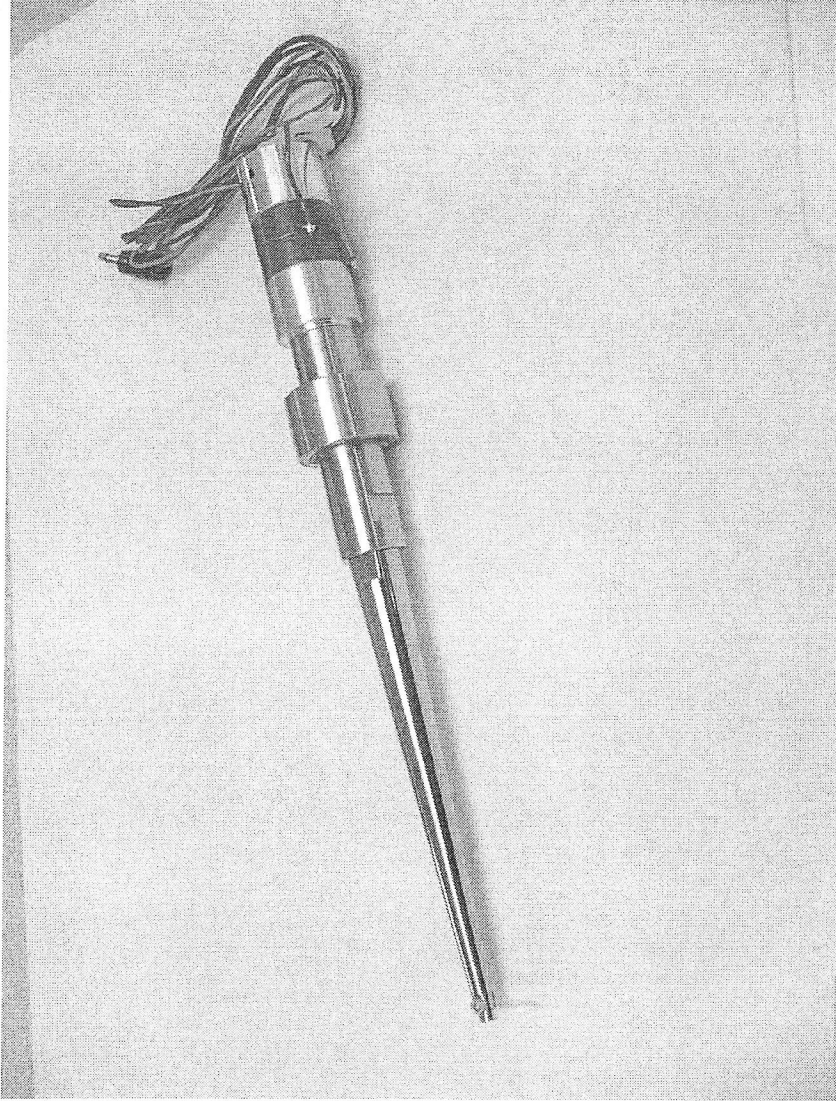

***Transducer Assembly with Capillary***

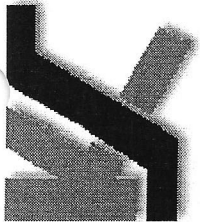

# **Manual Ball Bonder Short Course**

---

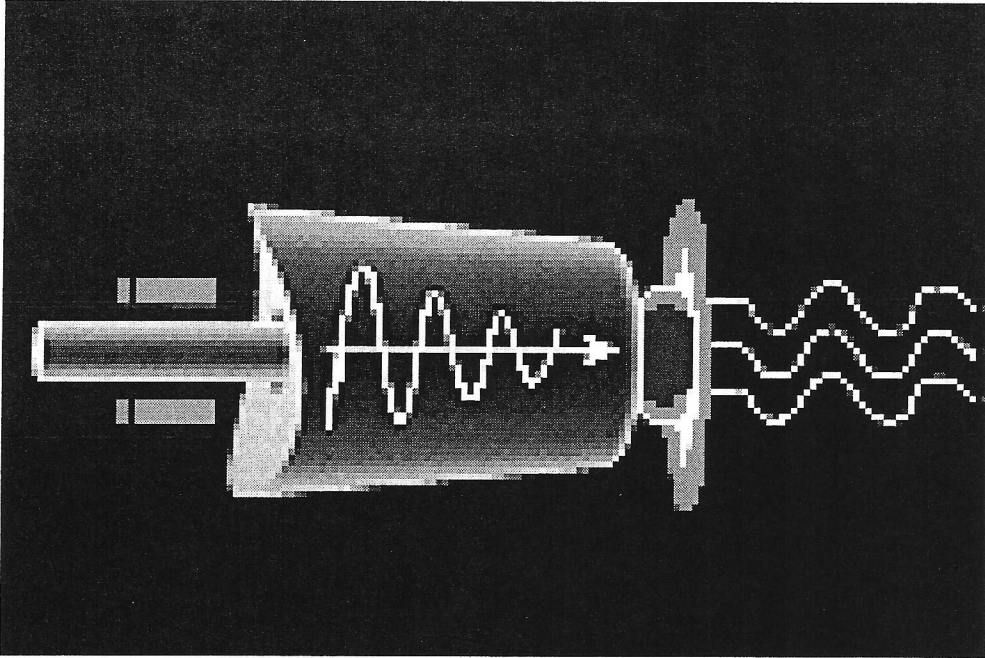

## ***A Thermosonic 1st Ball Bond Formation***

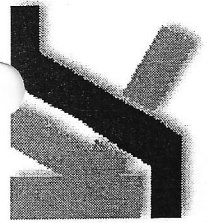

# Manual Ball Bonder Short Course

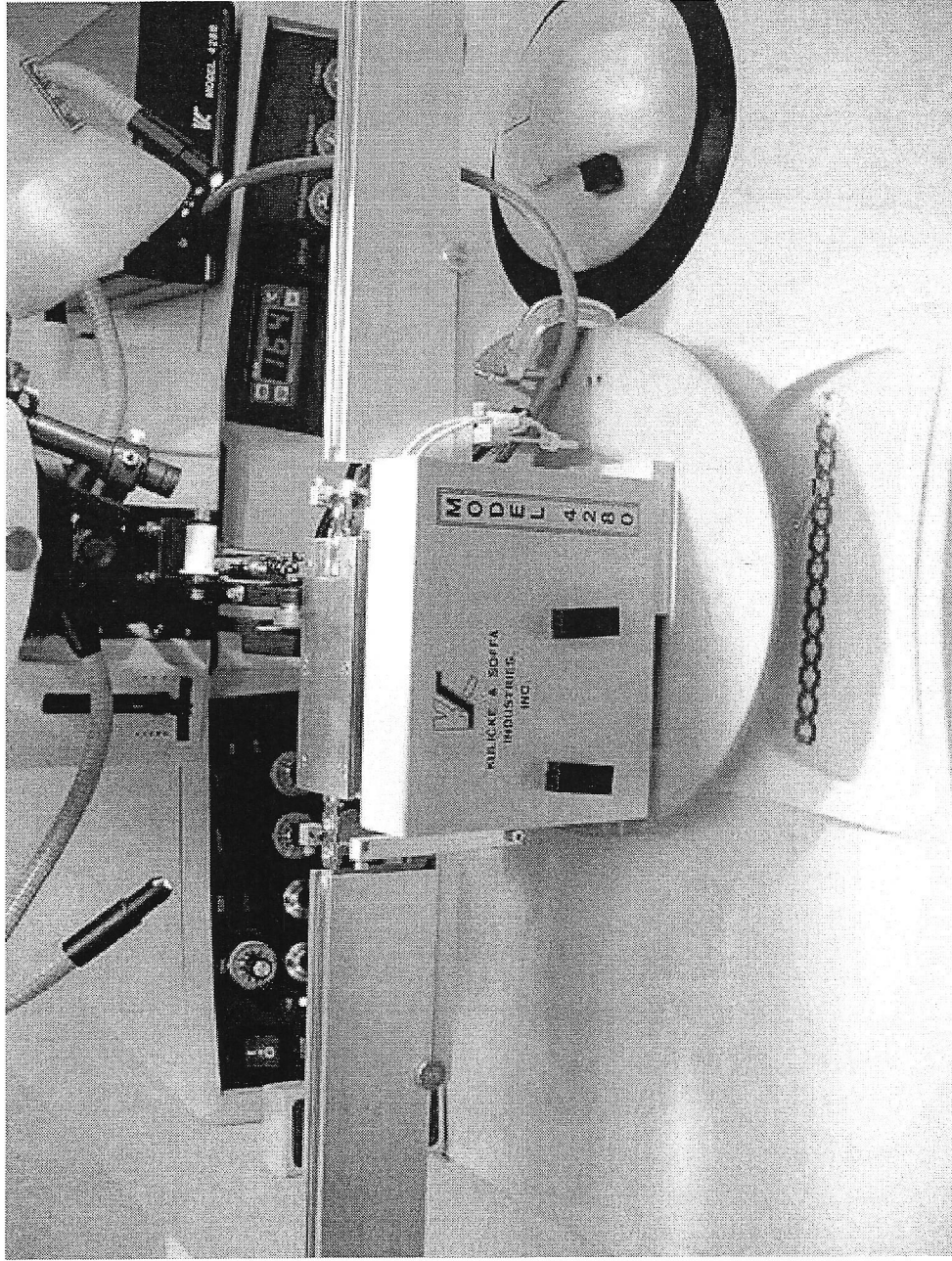

## Motorized Indexer on Manual Wire Bonding Machine

